



**TOP DISCHARGE INVERTER (TDI)  
FULL INVERTER SWIMMING POOL HEAT PUMP  
Installation & Instruction Manual**



**IMPORTANT NOTE:**

Thank you very much for purchasing our product. Before using your unit, please read this manual carefully and keep it for future reference.



# INDEX

1. FOREWORD.....	1
1.1 Read the Manual Before Operation .....	1
1.2 The Symbol Description of the Device .....	6
1.3 Statement .....	6
1.4 Safety Factors .....	6
2. OVER VIEW OF THE UNIT .....	9
2.1 Accessories Supplied With the Unit .....	9
2.2 Dimensions of the Unit .....	10
2.3 Main Parts of the Unit .....	11
2.4 Parameter of the Unit .....	12
3. INSTALLATION AND CONNECTION .....	13
3.1 Transportation .....	13
3.2 Notice Before Installation .....	13
3.3 Installation Instruction .....	14
3.3.1 Pre-requirements .....	14
3.3.2 Heat Pump Installation .....	14
3.3.3 Location and Space .....	15
3.3.4 Installation Layout .....	16
3.3.5 Electrical Installation .....	18
3.3.6 Electrical Connection .....	19
3.3.7 Third Party Controllers & Pool Pump connections .....	19
3.4 Trial After Installation .....	21
3.4.1 Inspection Before Trial Running .....	21
3.4.2 Trial Running .....	21
4. CONTROLLER OPERATION .....	22
4.1. Control Panel Diagram .....	22
4.2. Key Operating Instruction .....	23
4.2.1 Target temperature setting .....	23
4.2.2 ON/OFF Function .....	23
4.2.3 Mode Selection Function .....	23
4.2.4 Frequency settings .....	24
4.2.5 Lock screen function .....	25
4.2.6 Current faults .....	25
4.2.7 Status Inquiry .....	26
4.2.8 Setting interface .....	26
4.2.9 Curve .....	30
4.3. User Parameters .....	32
4.4. Fault & Protections .....	33
5. Wi-Fi Settings .....	34
5.1 Software Installation .....	34
5.2 Software Startup .....	35

5.3 Software Registration and Configuration .....	35
5.4 Wi-Fi Connection .....	38
5.5 Software Function Operation .....	45
5.6 Device Removal .....	49
6. MAINTENANCE AND WINTERZING .....	52
6.1 Maintenance .....	52
6.2 Winterizing .....	52
7. Warranty Information .....	53

# 1. FOREWORD

## 1.1 Read the Manual Before Operation

### **WARNING**

Do not use means to accelerate the defrosting process or to clean, other than those recommended by the manufacturer. The appliance shall be stored in a room without continuously operating ignition sources (For example: open flames, an operating gas appliance or an operating electric heater.)

Do not pierce or burn.

Be aware that refrigerants may not contain an odour.

### **Initial safety checks shall include:**

- ① that capacitors are discharged: this shall be done in a safe manner to avoid possibility of sparking;
- ② that no live electrical components and wiring are exposed while charging, recovering or purging the system;
- ③ that there is continuity of earth bonding.

### **Checks to the area**

Prior to beginning work on systems containing flammable refrigerants, safety checks are necessary to ensure that the risk of ignition is minimized. For repair to the refrigerating system, the following precautions shall be completed prior to conducting work on the system.

### **Work procedure**

Work shall be undertaken under a controlled procedure so as to minimize the risk of a flammable gas or vapour being present while the work is being performed.

### **General work area**

All maintenance staff and others working in the local area shall be instructed on the nature of work being carried out. Work in confined spaces shall be avoided.

### **Checking for presence of refrigerant**

The area shall be checked with an appropriate refrigerant detector prior to and during work, to ensure the technician is aware of potentially flammable atmospheres. Ensure that the leak detection equipment being used is suitable for use with flammable refrigerants, i.e. non-sparking, adequately sealed or intrinsically safe.

### **Presence of fire extinguisher**

If any hot work is to be conducted on the refrigerating equipment or any associated parts, appropriate fire extinguishing equipment shall be available to hand. Have a dry powder or CO<sub>2</sub> fire extinguisher adjacent to the charging area.

### **No ignition sources**

No person carrying out work in relation to a refrigeration system which involves exposing any pipe work that contains or has contained flammable refrigerant shall use any sources of ignition in such a manner that it may lead to the risk of fire or explosion. All possible ignition sources, including cigarette smoking, should be kept sufficiently far away from the site of installation, repairing, removing and disposal, during which flammable refrigerant can possibly be released to the surrounding space. Prior to work taking place, the area around the equipment is to be surveyed to make sure that there are no flammable hazards or ignition risks. "No Smoking" signs shall be displayed.

### **Ventilated area**

Ensure that the area is in the open or that it is adequately ventilated before breaking into the system or conducting any hot work. A degree of ventilation shall continue during the period that the work is carried out. The ventilation should safely disperse any released refrigerant and preferably expel it externally into the atmosphere.

### **Checks to the refrigeration equipment**

Where electrical components are being changed, they shall be fit for the purpose and to the correct specification. At all times the manufacturer's maintenance and service guidelines shall be followed. If in doubt consult the manufacturer's technical department for assistance.

The following checks shall be applied to installations using flammable refrigerants:

- ① the charge size is in accordance with the room size within which the refrigerant containing parts are installed;
- ② the ventilation machinery and outlets are operating adequately and are not obstructed;
- ③ if an indirect refrigerating circuit is being used, the secondary circuit shall be checked for the presence of refrigerant;
- ④ markings for the equipment continues to be visible and legible. Markings and signs that are illegible shall be corrected;
- ⑤ refrigeration pipe or components are installed in a position where they are unlikely to be exposed to any substance which may corrode refrigerant containing components, unless the components are constructed of materials which are inherently resistant to being corroded or are suitably protected against being so corroded.

### **Repairs to sealed components**

**DD.5.1** During repairs to sealed components, all electrical supplies shall be disconnected from the equipment being worked upon prior to any removal of sealed covers, etc. If it is absolutely necessary to have an electrical supply to equipment during servicing, then a permanently operating form of leak detection shall be located at the most critical point to warn of a potentially hazardous situation.

**DD.5.2** Particular attention shall be paid to the following to ensure that by working on electrical components, the casing is not altered in such a way that the level of protection is affected. This shall include damage to cables, excessive number of connections, terminals not made to original specification, damage to seals, incorrect fitting of glands, etc.

Ensure that the apparatus is mounted securely.

Ensure that seals or sealing materials have not degraded to the point that they no longer serve the purpose of preventing the ingress of flammable atmospheres. Replacement parts shall be in accordance with the manufacturer's specifications.

### **Repair to intrinsically safe components**

Do not apply any permanent inductive or capacitance loads to the circuit without ensuring that this will not exceed the permissible voltage and current permitted for the equipment in use.

Intrinsically safe components are the only types that can be worked on while live in the presence of a flammable atmosphere. The test apparatus shall be at the correct rating.

Replace components only with parts specified by the manufacturer. Other parts may result in the ignition of refrigerant in the atmosphere from a leak.

NOTE: The use of silicon sealant can inhibit the effectiveness of some types of leak detection equipment.

Intrinsically safe components do not have to be isolated prior to working on them.

### **Cabling**

Check that cabling will not be subject to wear, corrosion, excessive pressure, vibration, sharp edges or any other adverse environmental effects. The check shall also take into account the effects of aging or continual vibration from sources such as compressors or fans.

### **Detection of flammable refrigerants**

Under no circumstances shall potential sources of ignition be used in the searching for or detection of refrigerant leaks. A halide torch (or any other detector using a naked flame) shall not be used.

### **Leak detection methods**

The following leak detection methods are deemed acceptable for systems containing flammable refrigerants.

Electronic leak detectors shall be used to detect flammable refrigerants, but the sensitivity may not be adequate, or may need re-calibration. (Detection equipment shall be calibrated in a refrigerant-free area.) Ensure that the detector is not a potential source of ignition and is suitable for the refrigerant used. Leak detection equipment shall be set at a percentage of the LFL of the refrigerant and shall be calibrated to the refrigerant employed and the appropriate percentage of gas (25% maximum) is confirmed.

Leak detection fluids are suitable for use with most refrigerants but the use of detergents containing chlorine shall be avoided as the chlorine may react with the refrigerant and corrode the copper pipe-work.

If a leak is suspected, all naked flames shall be removed/extinguished.

If a leakage of refrigerant is found which requires brazing, all of the refrigerant shall be recovered from the system, or isolated (by means of shut off valves) in a part of the system remote from the leak. Oxygen free nitrogen (OFN) shall then be purged through the system both before and during the brazing process.

### **Removal and evacuation**

When breaking into the refrigerant circuit to make repairs – or for any other purpose – conventional procedures shall be used. However, it is important that best practice is followed since flammability is a consideration. The following procedure shall be adhered to:

- ① remove refrigerant;
- ② purge the circuit with inert gas;
- ③ evacuate;
- ④ purge again with inert gas;
- ⑤ open the circuit by cutting or brazing.

The refrigerant charge shall be recovered into the correct recovery cylinders. The system shall be “flushed” with OFN to render the unit safe. This process may need to be repeated several times. Compressed air or oxygen shall not be used for this task.

Flushing shall be achieved by breaking the vacuum in the system with OFN and continuing to fill until the working pressure is achieved, then venting to atmosphere, and finally pulling down to a vacuum. This process shall be repeated until no refrigerant is within the system. When the final OFN charge is used, the system shall be vented down to atmospheric pressure to enable work to take place. This operation is absolutely vital if brazing operations on the pipework are to take place.

Ensure that the outlet for the vacuum pump is not close to any ignition sources and there is ventilation available.

### **Charging procedures**

In addition to conventional charging procedures, the following requirements shall be followed:

- ① Ensure that contamination of different refrigerants does not occur when using charging equipment. Hoses or lines shall be as short as possible to minimize the amount of refrigerant contained in them. Cylinders shall be kept upright.
- ② Ensure that the refrigeration system is earthed prior to charging the system with refrigerant.
- ③ Label the system when charging is complete (if not already).
- ④ Extreme care shall be taken not to overfill the refrigeration system. Prior to recharging the system, it shall be pressure tested with OFN. The system shall be leak tested on completion of charging but prior to commissioning. A follow up leak test shall be carried out prior to leaving the site.

### **Decommissioning**

Before carrying out this procedure, it is essential that the technician is completely familiar with the equipment and all its detail. It is recommended good practice that all refrigerants are recovered safely. Prior to the task being carried out, an oil and refrigerant sample shall be taken in case analysis is required prior to re-use of reclaimed refrigerant. It is essential that electrical power is available before the task is commenced.

- ① Become familiar with the equipment and its operation.
- ② Isolate system electrically.
- ③ Before attempting the procedure ensure that:
  - mechanical handling equipment is available, if required, for handling refrigerant cylinders;
  - all personal protective equipment is available and being used correctly;



- the recovery process is supervised at all times by a competent person;
  - recovery equipment and cylinders conform to the appropriate standards.
- ④ Pump down refrigerant system, if possible.
  - ⑤ If a vacuum is not possible, make a manifold so that refrigerant can be removed from various parts of the system.
  - ⑥ Make sure that cylinder is situated on the scales before recovery takes place.
  - ⑦ Start the recovery machine and operate in accordance with manufacturer's instructions.
  - ⑧ Do not overfill cylinders. (No more than 80 % volume liquid charge).
  - ⑨ Do not exceed the maximum working pressure of the cylinder, even temporarily.
  - ⑩ When the cylinders have been filled correctly and the process completed, make sure that the cylinders and the equipment are removed from site promptly and all isolation valves on the equipment are closed off.
  - ⑪ Recovered refrigerant shall not be charged into another refrigeration system unless it has been cleaned and checked.

### **Labeling**

Equipment shall be labeled stating that it has been decommissioned and emptied of refrigerant. The label shall be dated and signed. Ensure that there are labels on the equipment stating the equipment contains flammable refrigerant.

### **Recovery**

When removing refrigerant from a system, either for servicing or decommissioning, it is recommended good practice that all refrigerants are removed safely. When transferring refrigerant into cylinders, ensure that only appropriate refrigerant recovery cylinders are employed. Ensure that the correct number of cylinders for holding the total system charge are available. All cylinders to be used are designated for the recovered refrigerant and labeled for that refrigerant (i.e. special cylinders for the recovery of refrigerant). Cylinders shall be complete with pressure relief valve and associated shut-off valves in good working order. Empty recovery cylinders are evacuated and, if possible, cooled before recovery occurs.

The recovery equipment shall be in good working order with a set of instructions concerning the equipment that is at hand and shall be suitable for the recovery of flammable refrigerants.

In addition, a set of calibrated weighing scales shall be available and in good working order.





Hoses shall be complete with leak-free disconnect couplings and in good condition. Before using the recovery machine, check that it is in satisfactory working order, has been properly maintained and that any associated electrical components are sealed to prevent ignition in the event of a refrigerant release. Consult manufacturer if in doubt.

The recovered refrigerant shall be returned to the refrigerant supplier in the correct recovery cylinder, and the relevant Waste Transfer Note arranged. Do not mix refrigerants in recovery units and especially not in cylinders.

If compressors or compressor oils are to be removed, ensure that they have been evacuated to an acceptable level to make certain that flammable refrigerant does not remain within the lubricant. The evacuation process shall be carried out prior to returning the compressor to the suppliers. Only electric heating to the compressor body shall be employed to accelerate this process. When oil is drained from a system, it shall be carried out safely.

## 1.2 The Symbol Description of the Device

The precautions listed here are divided into the following types. They are quite important, so be sure to follow them carefully. Meanings of DANGER, WARNING, CAUTION and NOTE symbols.

Symbols	Meaning	Description
	<b>WARNING</b>	The symbol shows that this appliance uses a flammable refrigerant. If the refrigerant is leaked and exposed to an external ignition source, there is a risk of fire.
	<b>WARNING</b>	The symbol shows that this appliance uses a low burning velocity material. Please keep away from fire source.
	<b>CAUTION</b>	This symbol shows that the operation manual should be read carefully.
	<b>CAUTION</b>	This symbol shows that a service personnel should be handling this equipment with reference to the installation manual.
	<b>CAUTION</b>	This symbol shows that information is available such as the operating manual or installation manual.

## 1.3 Statement

To keep users under safe working condition and property safety, please follow the instructions below:

- ① Wrong operation may result in injury or damage;
- ② Please install the unit in compliance with local laws, regulations and standards;
- ③ Confirm power voltage and frequency;
- ④ The unit is only used with grounding sockets;
- ⑤ Independent switch must be offered with the unit.

## 1.4 Safety Factors

The following safety factors need to be considered:

- ① Please read the following warnings before installation;
- ② Be sure to check the details that need attention, including safety factors;
- ③ After reading the installation instructions, be sure to save them for future reference.

### **Warning**

Make sure that the unit is installed safely and reliably.

- If the unit is not secure or not installed, it may cause damage. The minimum support weight required for installation is 21g/mm<sup>2</sup>

- If the unit was installed in a closed area or limited space, please consider the size of room and ventilation to prevent suffocation caused by refrigerant leakage.

- ① Use a specific wire and fasten it to terminal block so that the connection will prevent pressure from being applied to parts.

- ② Wrong wiring will cause fire.

Please connect power wire accurately according to wiring diagram on the manual to avoid burnout of the unit or fire.

- ③ Be sure to use correct material during installing.

Wrong parts or wrong materials may result in fire, electric shock, or falling of the unit.

- ④ Install on the ground safely, please read installation instructions.

Improper installation may result in fire, electric shock, falling of the unit, or water leaking.

- ⑤ Use professional tools for doing electrical work.

If power supply capacity is insufficient or circuit is not completed, it may cause fire or electric shock.

- ⑥ The unit must have grounding device.

If power supply does not have grounding device, be sure not to connect the unit.

- ⑦ The unit should be only removed and repaired by professional technician.

Improper movement or maintenance of the unit may cause water leakage, electric shock, or fire.

Please find a professional technician to do.

- ⑧ Don't unplug or plug power during operation. It may cause fire or electric shock.

- ⑨ Don't touch or operate the unit when your hands are wet. It may cause fire or electric shock.

- ⑩ Don't place heaters or other electrical appliances near the power wire. It may cause fire or electric shock.

- ⑪ The water must not be poured directly from the unit. Do not let water to permeate into the electrical components.

 **Warning**

- ① Do not install the unit in a location where there may be flammable gas.

- ② If there is flammable gas around the unit, it will cause explosion.

According to the instruction to carry out drainage system and pipeline work. If drainage system or pipeline is defective, water leakage will occur. And it should be disposed immediately to prevent other household products from getting wet and damage.

- ③ Do not clean the unit while power is on. Turn off power before cleaning the unit. If not it may result in injury from a high-speed fan or electric shock.

- ④ Stop operating the unit once there is a problem or a fault code.

Please turn off power and stop running the unit. Otherwise it may cause electric shock or fire.

- ⑤ Be careful when the unit is not packed or not installed.

Pay attention to sharp edges and fins of heat exchanger.

- ⑥ After installation or repair, please confirm refrigerant is not leaking.

If refrigerant is not enough, the unit will not work properly.

- ⑦ The installation of external unit must be flat and firm.

Avoid abnormal vibration and noise.

- ⑧ Don't put your fingers into fan and evaporator.

High speed running fan will result in serious injury.

- ⑨ This device is not designed for people who is physically or mentally weak (including children)

and who does not have experience and knowledge of heating and cooling system. Unless it is used under direction and supervision of professional technician, or has received training on the using of this unit. Children must use it under supervision of an adult to ensure that they use the unit safely. If power wire is damaged, it must be replaced by a professional technician to avoid danger.

## 2. OVER VIEW OF THE UNIT



### 2.1 Accessories Supplied With the Unit

After unpacking, please check if you have all the following components.

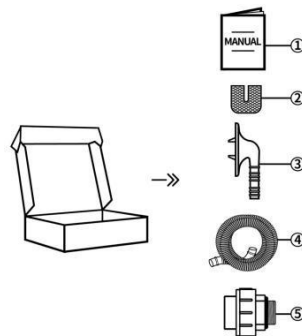

NO.	Components	Quantity	NO.	Components	Quantity
①	User Manual	1	④	Drain Pipe	1
②	U-type Rubber Blanket	4	⑤	Water Pipe Joint	2
③	Drain Connector	1			

## 2.2 Dimensions of the Unit

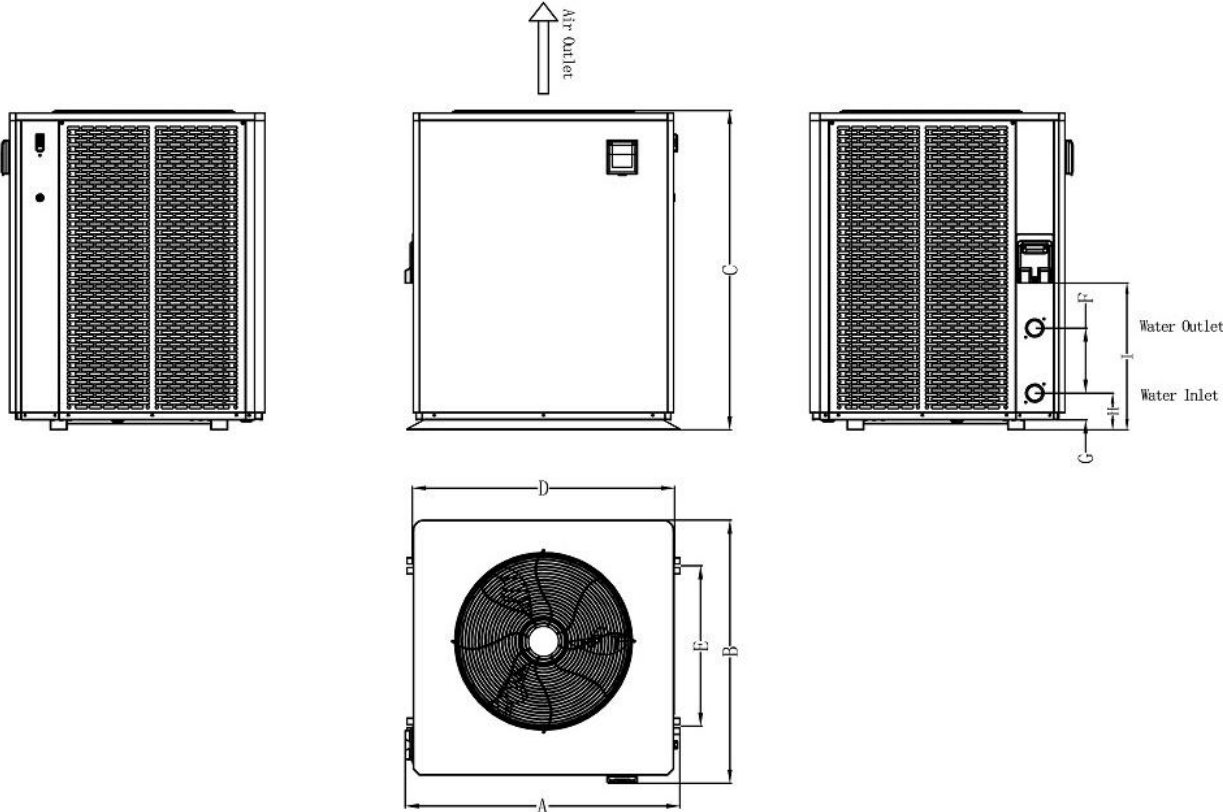

Dimension Unit: (mm)

Model	A	B	C	D	E	F	G	H	I
TDI 35	907	842	1052	865	530	215	88	122	486

## 2.3 Main Parts of the Unit

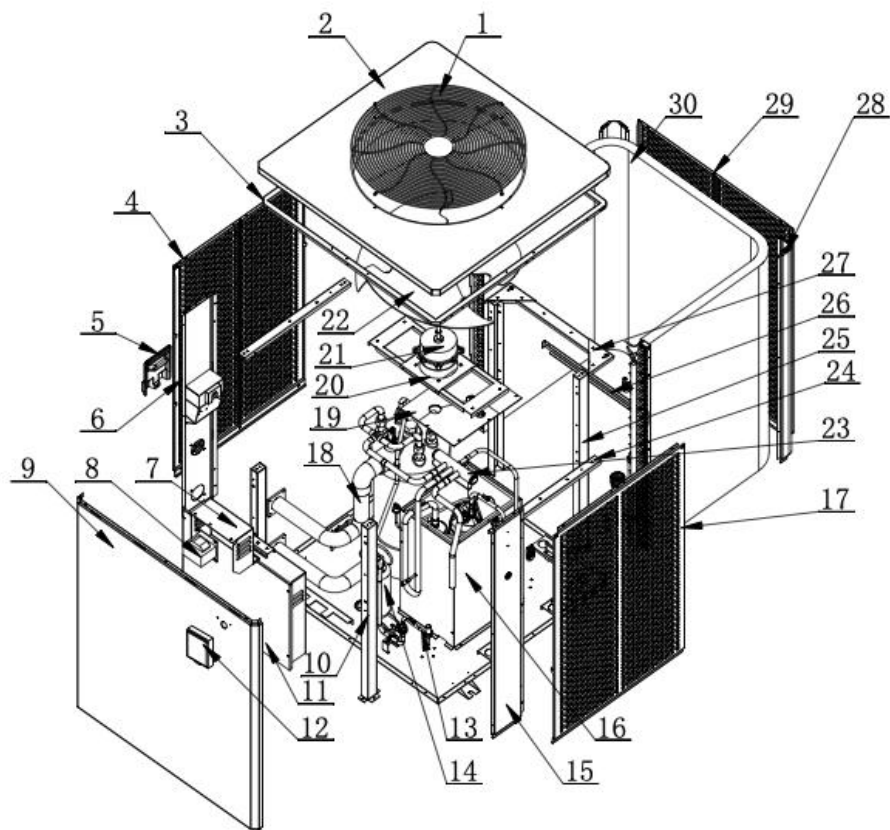

1	Mesh Cover	11	Electrical Box	21	Fan Motor
2	Top Cover	12	Wire Controller	22	Fan Blade
3	Top Frame	13	Throttling Device Assembly	23	4-Way Valve Assembly
4	Left Plate	14	Liquid Reservoir	24	Left/Right Crossbeam
5	Transition Pipe Handle	15	Right Column	25	Back Left/Right Column
6	Left Column	16	Compressor Compartment	26	Column Fixing Strip
7	Fixing Plate	17	Right Plate	27	Column Triangular Plate
8	Reactor	18	Titanium Heat Exchanger	28	Back Column
9	Front Plate	19	Compressor Compartment Cover	29	Back Plate
10	Front Left/Right Column	20	Motor Support	30	Fin Heat Exchanger

## 2.4 Parameter of the Unit

Model	TDI 35
<b>Air Temperature: 27°C, inlet/outlet water temperature: 26°C/28°C, humidity 80%</b>	
Heating capacity (kW)	11.56~34.8
Power input (kW)	0.74~5.39
COP	15.62~6.46
<b>Air Temperature: 15°C, inlet/outlet water temperature: 26°C/28°C, humidity 70%</b>	
Heating capacity (kW)	9.44~25.9
Power input (kW)	1.35~5.44
COP	6.99~4.76
Power supply (V/Ph/Hz)	380-415V/3N~/50Hz
Max power input (kW)	7.0
Max current (A)	13.2
Setting temperature range (Heating)	15°C~40°C
Setting temperature range (Cooling)	8°C~28°C
Running temperature range	-10°C~43°C
Refrigerant / Quantity(kg)	R32 / 2.8
Compressor	Mitsubishi, Twin Rotary DC Inverter
Gas control	EEV
Fan type	DC Inverter, Vertical
Air side heat exchanger	Hydrophilic fin and tube
Water side heat exchanger	Titanium Heat Exchanger
Water flow (LPM)	235
Water Pressure Drop(max.) (kPa)	35
Net dimension LxWxH (mm)	907×842×1052
Water pipe connection (mm)	40/50
Net weight (kg)	141
Noise level dB(A)	46-62
Max./Min. Water operating pressure (MPa)	0.6/0.1
Max./Min. Water inlet pressure (MPa)	0.6/0.1
Water proof level	IPX4



### 3. INSTALLATION AND CONNECTION

**⚠ WARNING:** The heat pump must be installed by a professional team. The users are not qualified to install by themselves, otherwise the heat pump might be damaged and risky for users' safety.

This section is provided for information purposes only and must be checked and adapted if necessary according to the actual installation conditions.

#### 3.1 Transportation

1. When storing or moving the heat pump, the heat pump should be at the upright position.

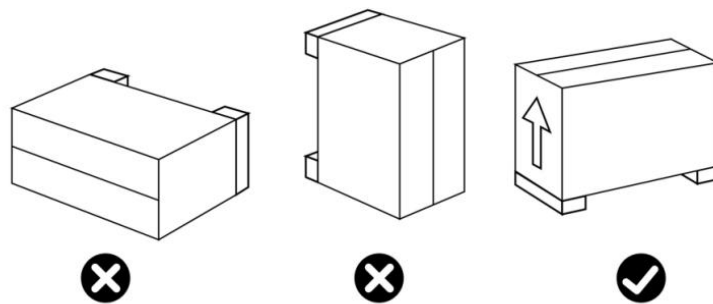

2. When moving the heat pump, do not lift the water union since the titanium heat exchanger inside the heat pump will be damaged.

#### 3.2 Notice Before Installation

1. The inlet and outlet water unions can't bear the weight of soft pipes. The heat pump must be connected with hard pipes!

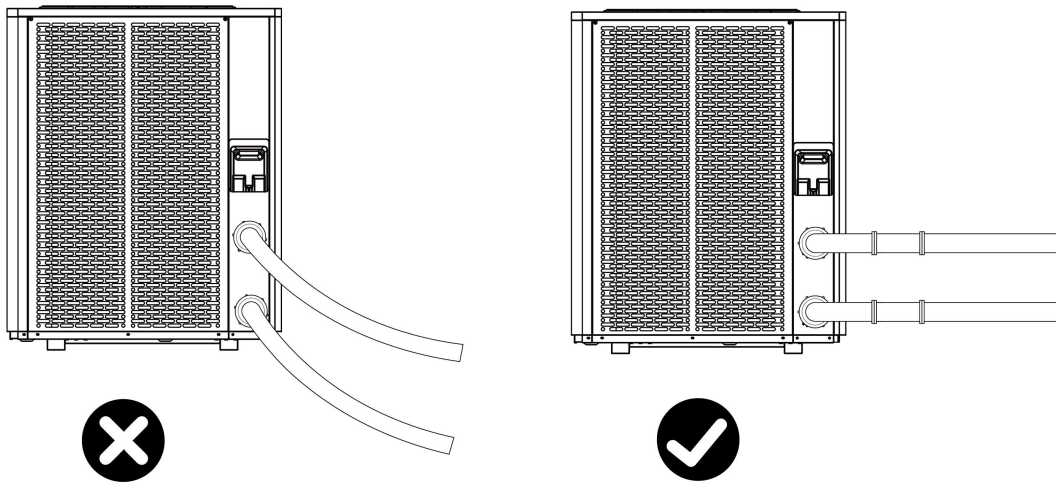

2. In order to guarantee the heating efficiency, the water pipe length should be  $\leq 10\text{m}$  between the pool and the heat pump.

### 3.3 Installation Instruction

#### 3.3.1 Pre-requirements

##### Equipment necessary for the installation of your heat pump:

- ① Power supply cable suitable for the unit's power requirements.
- ② A By-Pass kit and an assembly of PVC tubing suitable for your installation as well as pvc primer & pvc solvent, PVC adhesive and sandpaper.
- ③ A set of wall plugs and expansion screws suitable to attach the unit to your support.
- ④ Suitable fastening studs may be used to raise the unit.

#### 3.3.2 Heat Pump Installation

- ① The unit can be fixed by bolts (M10) to concrete foundation or brackets. The concrete foundation must be solid; the bracket must be strong enough and anti-rust treated;
- ② The heat pump needs a water pump (Supplied by the user). The recommended pump specification-flux: refer to Technical Parameter, Max. lift  $\geq 10\text{m}$ ;
- ③ When the heat pump is running, there will be condensation water discharged from the bottom, please pay attention to it. Please insert the drainage tube (accessory) into the hole and clip it well, then connect a pipe to drain off the condensation water. Install the heat pump, raising it at least 10 cm with solid water-resistant pads, then connect the drainage pipe to the opening located under the pump.

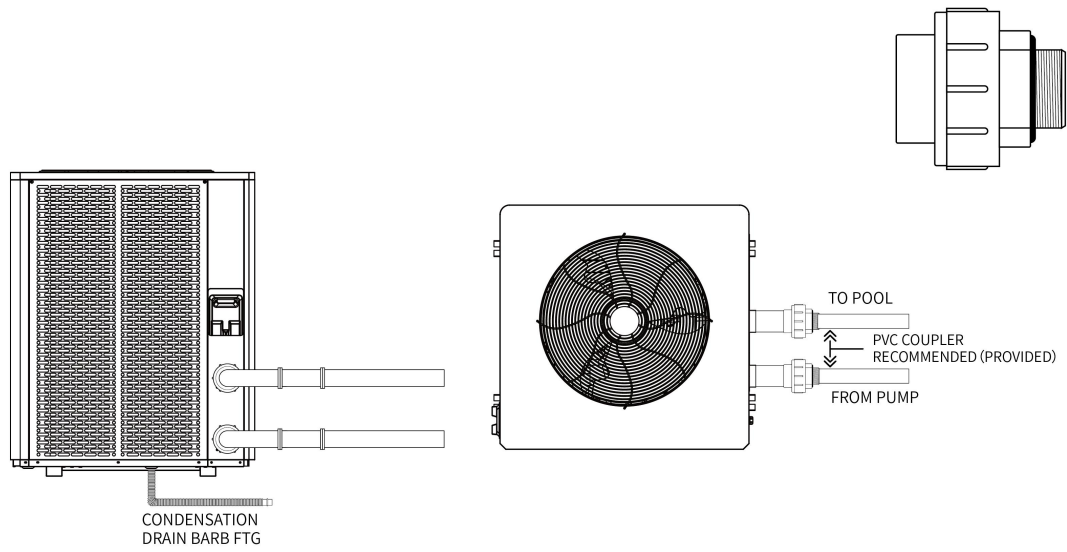

④ There are two methods to fixed heat pump chassis.  
 Method 1: Sheet metal foot fixed.

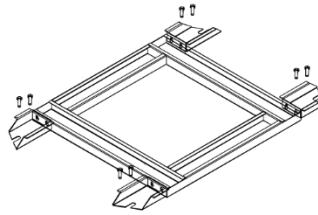

Method 2: Rubber blanket fixed.

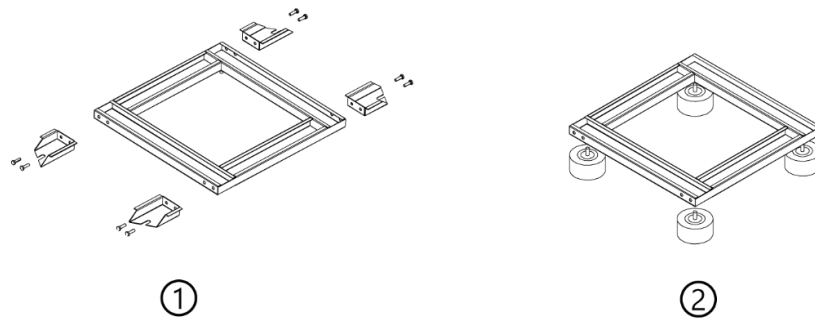

### 3.3.3 Location and Space

Please comply with the following rules concerning the choice of heat pump location.

- ① The unit's future location must be easily accessible for convenient operation and maintenance.
- ② It must be installed on the ground, fixed ideally on a level concrete floor. Ensure that the

floor is sufficiently stable and can support the weight of the unit.

- ③ A water drainage device must be provided close to the unit in order to protect the area where it is installed.
- ④ If necessary, the unit may be raised by using suitable mounting pads designed to support its weight.
- ⑤ Check that the unit is properly ventilated, that the air outlet is not facing the windows of neighbouring buildings and that the exhaust air cannot return. In addition, provide sufficient space around the unit for servicing and maintenance operations.
- ⑥ The unit must not be installed in an area exposed to oil, flammable gases, corrosive products, sulphur compounds or close to high frequency equipment.
- ⑦ To prevent mud splashes, do not install the unit near a road or track.
- ⑧ To avoid causing nuisance to neighbors, make sure the unit is installed so that it is positioned towards the area that is least sensitive to noise.
- ⑨ Keep the unit as much as possible out of the reach of children.
- ⑩ Installation space:

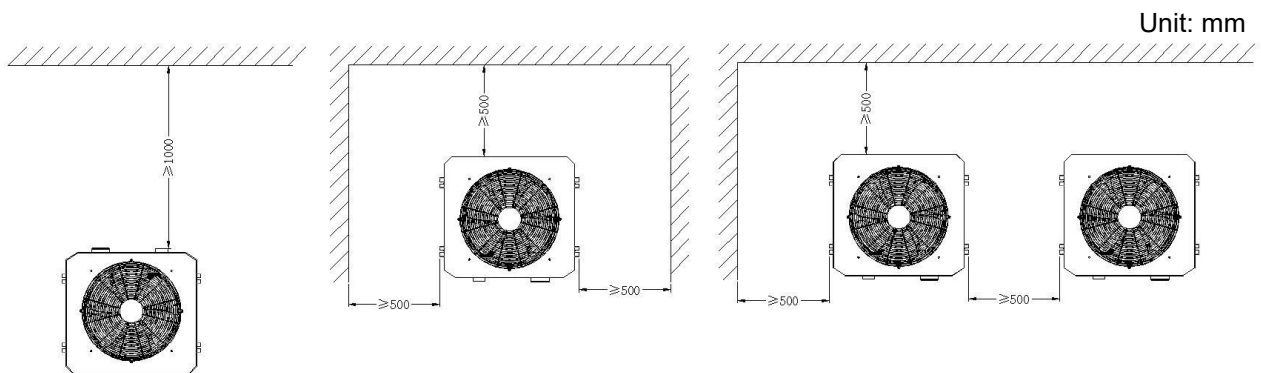

Do not put anything less than one meter in front of the heat pump.

Leave 500 mm of empty space on the sides and back of the heat pump and free ventilation above.

Do not leave any obstacles on the device!

### 3.3.4 Installation Layout

Notice: The filter must be cleaned regularly to ensure that water in the system is clean and avoid blocking of filter. It is necessary that drainage valve is fixed on the lower water pipe. If the unit is not running during winter months, please disconnect power supply and let out drain water from unit through drainage valve. If ambient temperature of running unit is below 0°C, please keep water pump running.

The installation diagram is shown in the following figure:

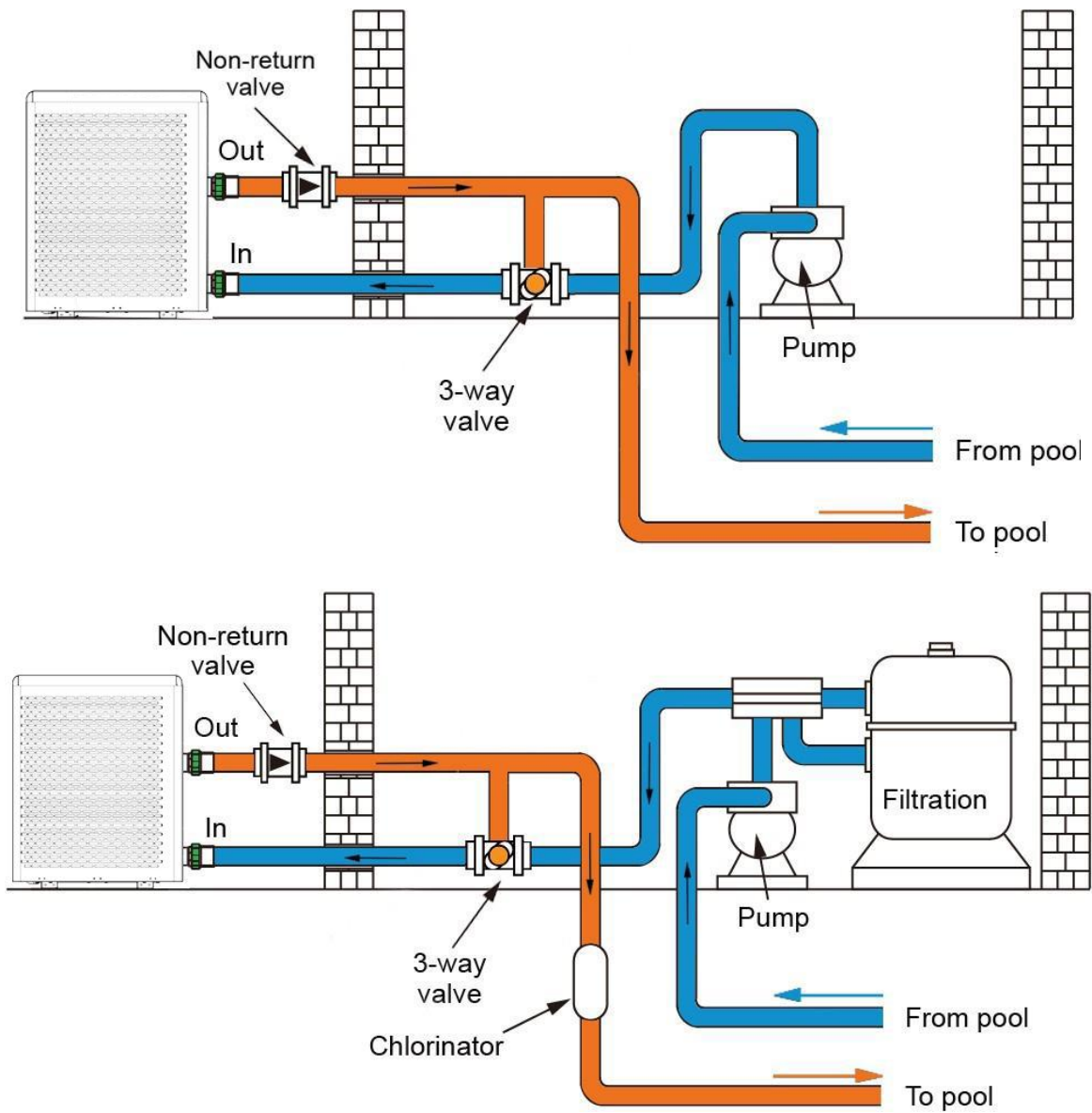

### SINGLE INSTALLATION DIAGRAM:

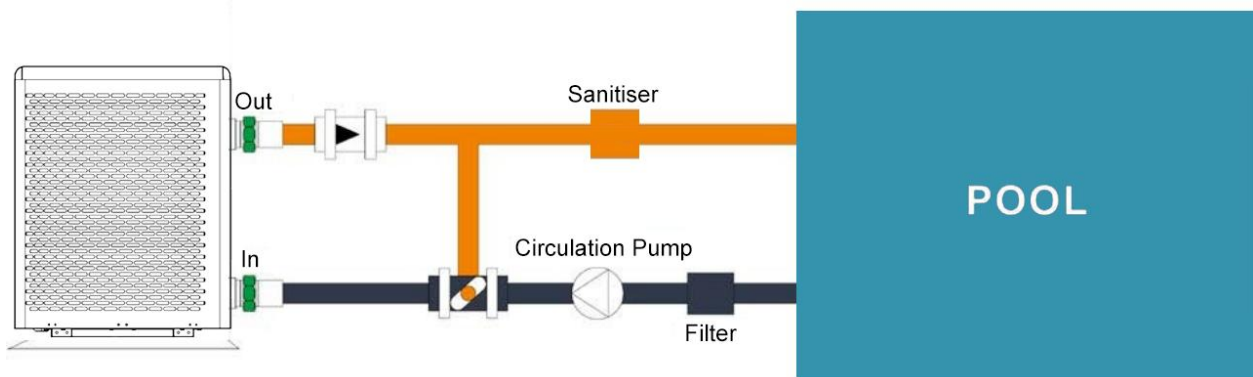

### SERIAL INSTALLATION DIAGRAM:

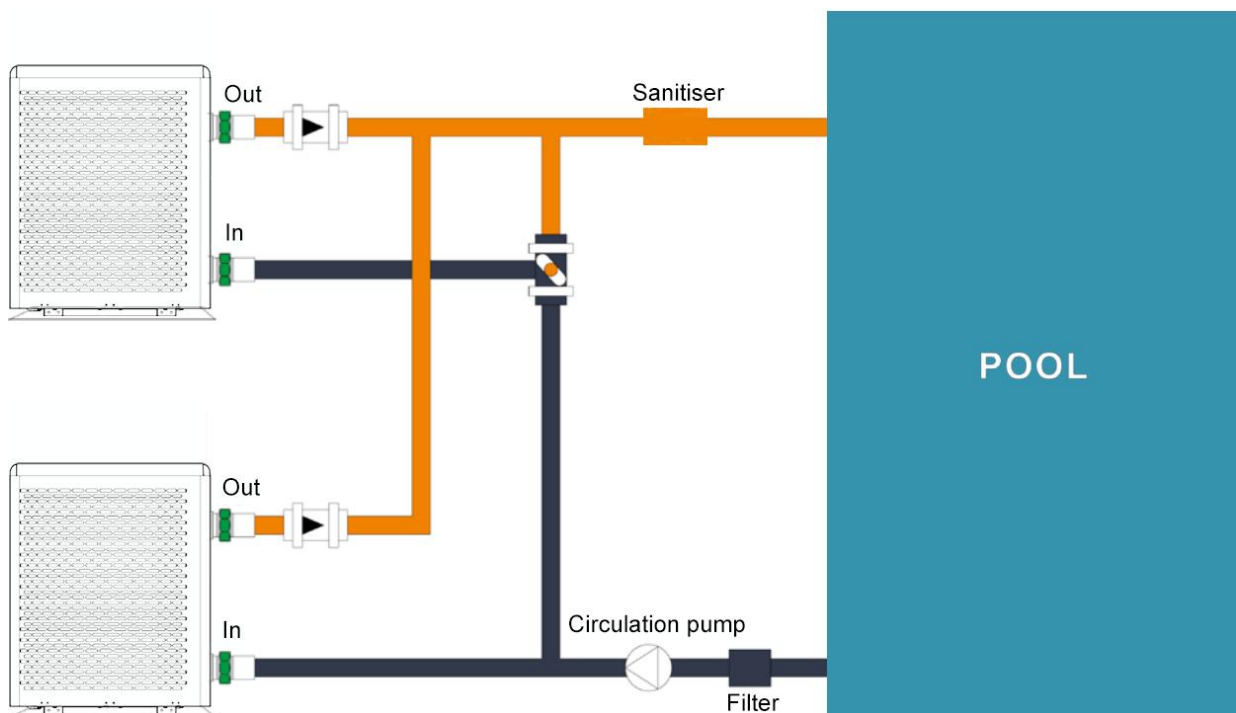

### 3.3.5 Electrical Installation

**This unit must be electrically connected following the AS/NZS 3000 Wiring rules!**

To function safely and maintain the integrity of your electrical system, the unit must be connected to a general electricity supply in accordance with the following regulations:

- ① Upstream, the general electricity supply must be protected by a 30mA differential switch.
- ② The heat pump must be connected to a suitable D-curve circuit breaker in accordance with current standards and regulations in the country where the system is installed.
- ③ The electricity supply cable must be adapted to match the unit's rated power and the length

of wiring required by the installation. The cable must be suitable for outdoor use.

- ④ For a three-phase system, it is essential to connect the phases in the correct sequence. If the phases are inverted, the heat pump's compressor will not work.
- ⑤ In places open to the public, it is mandatory to install an emergency stop button close to the heat pump.

Model	Power Supply Wires		
	Electricity Supply	Cable Diameter	Specification
TDI 35	380-415V/3N~/50Hz	5G 6.0mm <sup>2</sup>	AWG 10

### 3.3.6 Electrical Connection

**⚠ WARNING:** Power supply of heat pump must be disconnected before any operation. Please comply with the following instruction to connect heat pump.

Step 1: Detach electrical side panel by a screwdriver to access electrical terminal block.

Step 2: Insert cable into heat pump unit port.

Step 3: Connect power supply cable to terminal block according to the diagram below in 3.3.7.

### 3.3.7 Third Party Controllers & Pool Pump connections

Adding a third party controller to your heat pump is highly recommended. It is the preferred method to ensure smooth operation with a standalone pool pump as it means the pool pump does not need to have the power plug removed. In some instances, removing a power plug from a pool pump will void the manufacturers warranty - please check with your pool pump supplier / manufacturer before directly connecting a pool pump to this unit.

For ease of install the 3rd party controller should be connected to L1 & N1 on the power block.

Please note connecting a pool pump to this connection will not power the pump.

Please comply with the following instruction to connect heat pump.

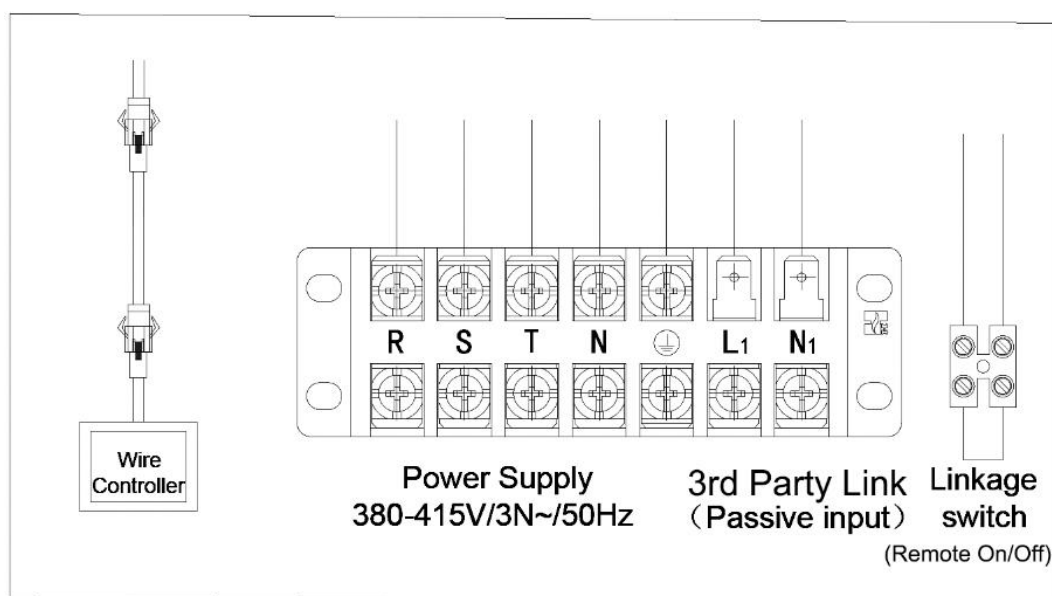

113-07-12-00143\_SY\_A0

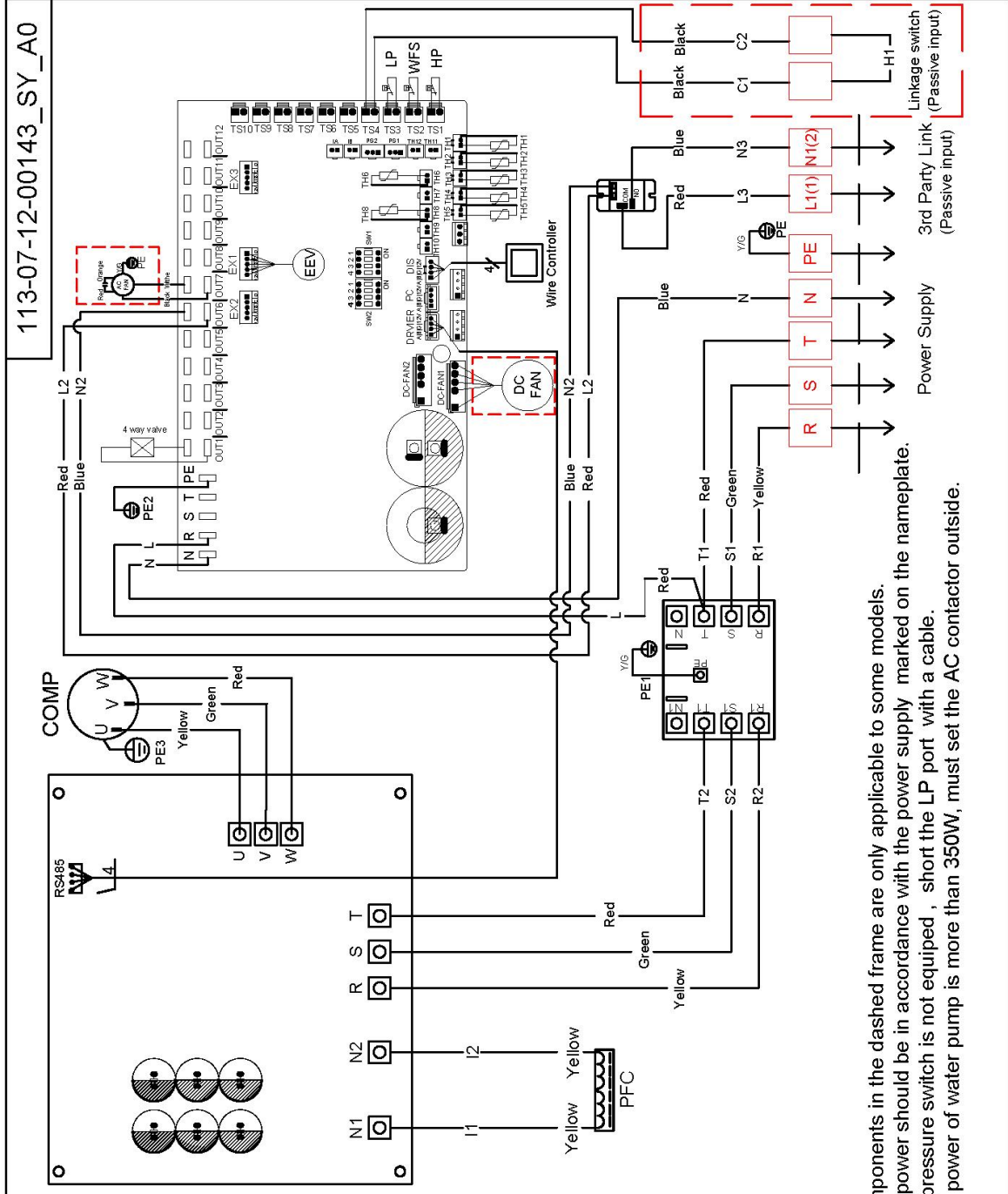

Symbol Note	
TH1	Ambient Temp.Sensor (Yellow)
TH2	Heating Coil Temp.Sensor (Blue)
TH3	Exhaust Temp.Sensor (Red)
TH4	Suction Temp.Sensor (Green)
TH5	Water Outlet Temp.Senso (Black)
TH6	Water Inlet Temp.Sensor (White)
TH8	Cooling Coil Temp.Sensor (Brown)
HP	High Pressure Switch
LP	Low Pressure Switch
WFS	Water Flow Switch
Y/G	Yellow/Green
FAN	Fan Motor
COMP	Compressor
EEV	Electronic Expansion Valve

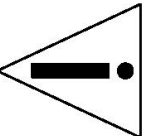

Notice:

1. Some components in the dashed frame are only applicable to some models.
2. The input power should be in accordance with the power supply marked on the nameplate.
3. If the low pressure switch is not equipped, short the LP port with a cable.
4. When the power of water pump is more than 350W, must set the AC contactor outside.



### 3.4 Trial After Installation

 **WARNING:** Please check all the wiring carefully before turning on the heat pump.

#### 3.4.1 Inspection Before Trial Running

Before running test, confirm below items and write √ in block;

<input type="checkbox"/>	Correct unit installation
<input type="checkbox"/>	Power supply voltage is the same as unit rated voltage
<input type="checkbox"/>	Correct piping and wiring
<input type="checkbox"/>	Air inlet & outlet port of unit is unblocked
<input type="checkbox"/>	Drainage and venting is unblocked and no water leaking
<input type="checkbox"/>	Leakage protector is working
<input type="checkbox"/>	Piping insulation is working
<input type="checkbox"/>	Ground wire is connected correctly

#### 3.4.2 Trial Running

Step 1: Running test can begin after completing all installation;

Step 2: All wiring and piping should be connected well and carefully checked, then fill water tank with water before power is switched on;

Step 3: Emptying all air within pipes and water tank, press “on-off” button on control panel to run the unit at setting temperature;

Step 4: Items need to be checked during running test:

- ① During the first running, unit current is normal or not;
- ② Each function button on control panel is normal or not;
- ③ Display screen is normal or not;
- ④ Are there any leakage in the whole heating circulation system;
- ⑤ Condensate drain is normal or not;
- ⑥ Are there any abnormal sound or vibration during running?

## 4. CONTROLLER OPERATION

### 4.1. Control Panel Diagram









#### Basic Icons

- ① Water inlet temperature
- ② ON/OFF
- ③ Mode
- ④ Frequency settings
- ⑤ Lock/Unlock
- ⑥ Target temp. setting
- ⑦ Current faults:

#### Icon Table:

Icon	Meaning	Remark	Icon	Meaning	Remark
	Networking Status	According to the signal strength display		Fault icon	Blinking
	Heating mode	Dynamic representative unit work		Silent mode	Static

	Automatic mode	Dynamic representative unit work		Powerful mode	Static
	Cooling mode	Dynamic representative unit work		Smart Mode	Static
	Defrosting mode	Static		Remote Icons	Effective flashing

## 4.2. Key Operating Instruction

### 4.2.1 Target temperature setting

Click on the target temperature setting icon, then you can enter the value, and finally click on the "OK" button to save it.

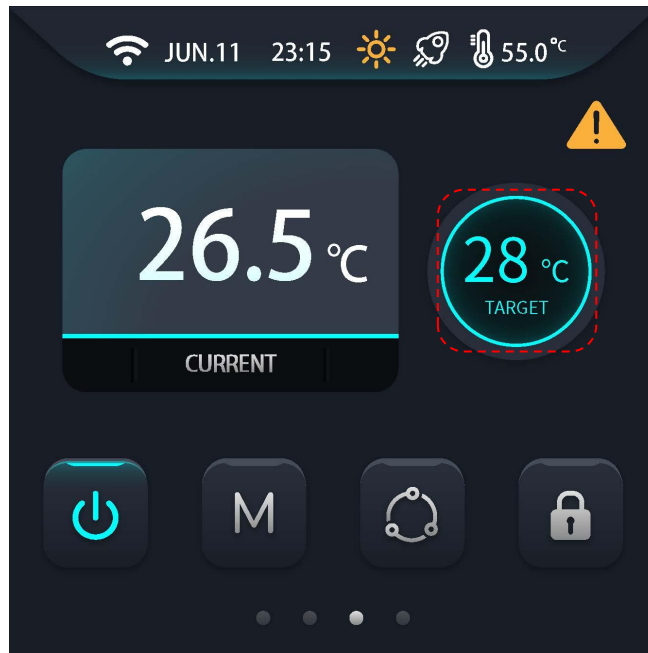

### 4.2.2 ON/OFF Function

At the main interface, click the “” button to turn the unit ON or OFF.

### 4.2.3 Mode Selection Function

Click on the “Mode” button to enter mode interface and select the unit operation mode.

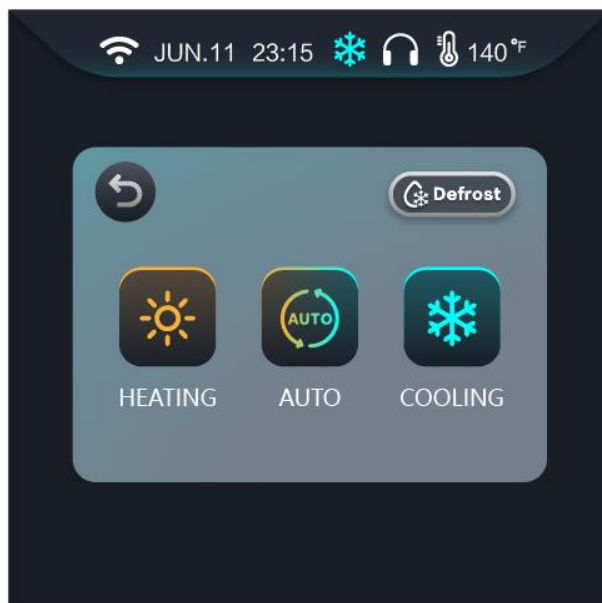

- ①  : Heating Mode
- ②  : Automatic Mode
- ③  : Cooling Mode
- ④  : Defrosting
- ⑤  : Return Button

One-Key Defrosting: click “”, the icon will lights up and does not go out until the unit has finished and exits defrost mode.

Notice: Defrosting cannot be performed in cooling mode

#### 4.2.4 Frequency settings

Click the “”button to enter the frequency setting interface.

There are three modes: Powerful, Silent and Smart.

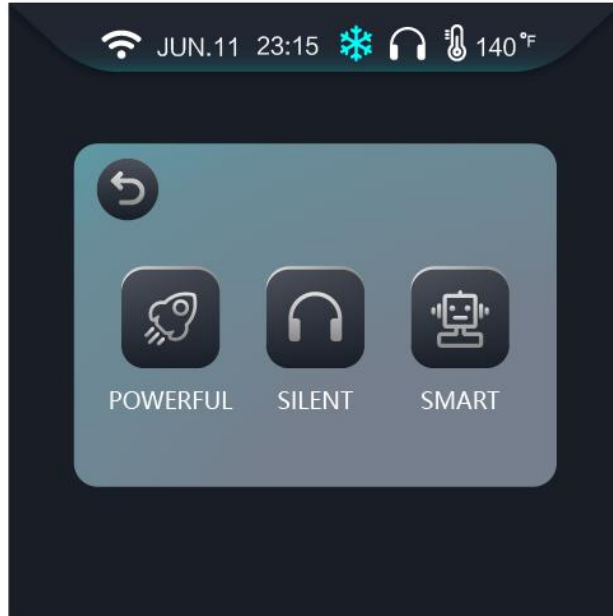

#### 4.2.5 Lock screen function

At the main interface, press “” to lock/unlock.

#### 4.2.6 Current faults

- a. When the unit is malfunctioning, the fault icon “” on the main interface flashes, click on the fault icon to enter the fault inquiry page;
- b. Fault support up to 3 pages of data query, the number of pages displayed according to the number of current fault decision;
- c. The current fault will display fault icon + fault code + fault name.

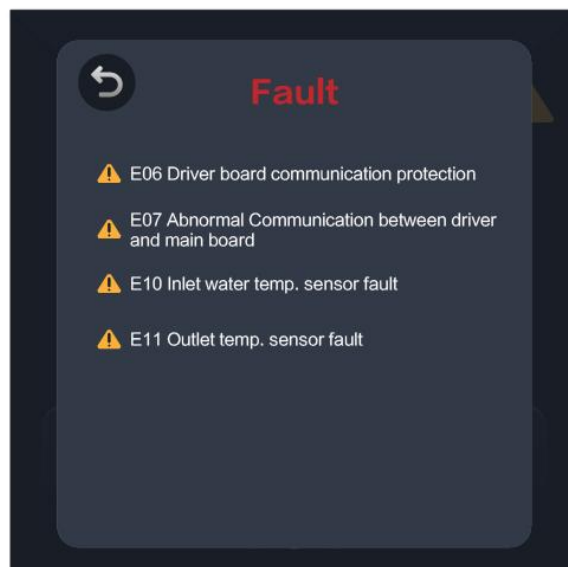

### 4.2.7 Status Inquiry

- a. At the main interface, swipe from right to left to check the current running status.
- b. Click on the triangle icon to view the lower parameters.



### 4.2.8 Setting interface

Swipe from left to the right at the main interface to enter the settings interface.

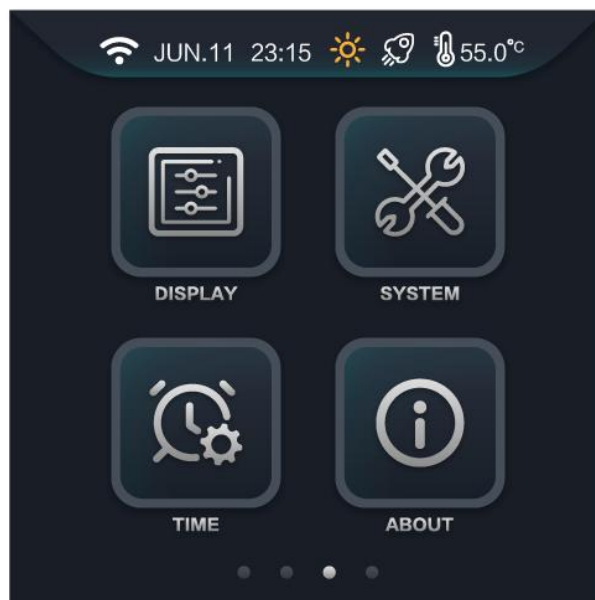

## Display Interface

At the settings interface, press “” to enter the display interface.

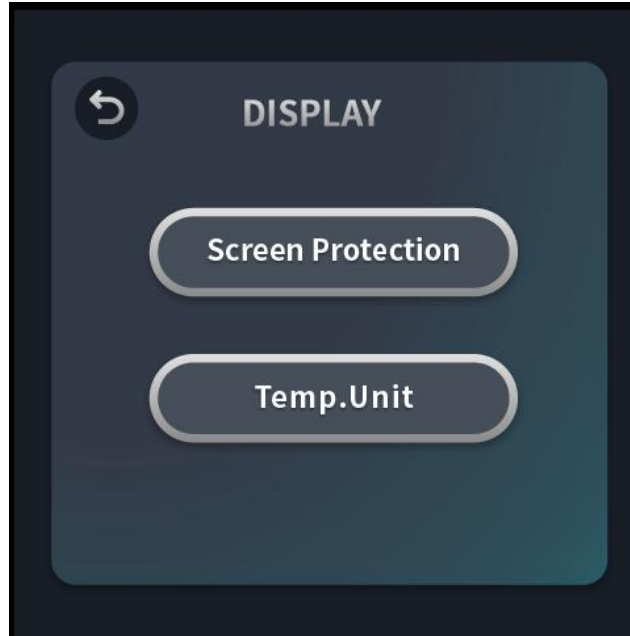

### ● Screen Protection Interface

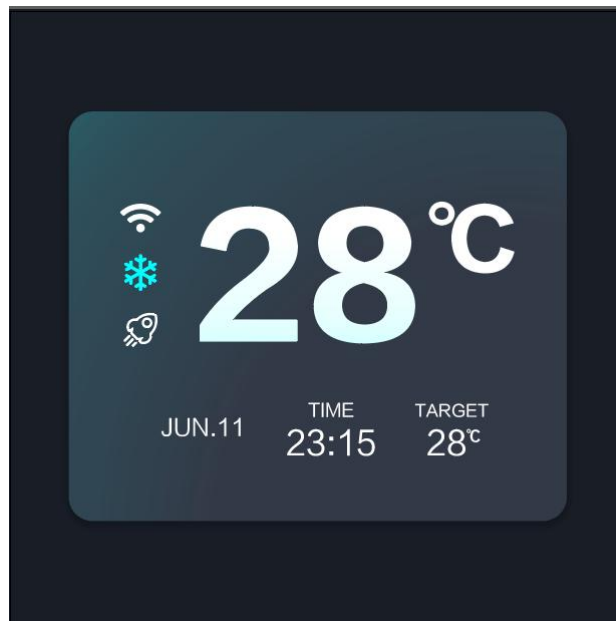

a. The screen protection function is on:

The display will switch to the screen protection interface when there is no operation for five minutes, and then automatically turn off after two minutes without any operation;

b. The screen protection function is off:

The display will automatically turn off after five minutes without any operation.

c. When the display screen is powered off:

- a) The screen protection function is on: Click anywhere on the screen, the screen displays the screen protection interface, you need to click on the screen again to exit the screen protection and enter the main interface;
- b) The screen protection function is off: click anywhere on the screen, the screen will light up and automatically enter the main interface.

● Temperature unit setting

Click on °C/°F to toggle the temperature unit.



## System Parameters

At the settings interface, press “” to enter the password interface.



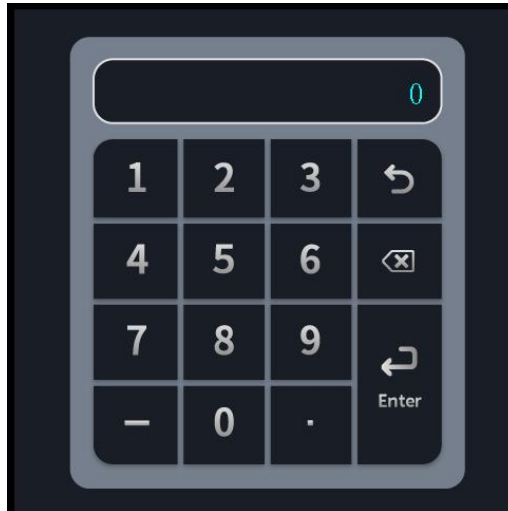

- Restore factory settings

Enter "400866" in the password interface that will automatically pop up a window prompting whether to restore the factory settings;

- User parameter setting

Enter "168" in the password interface to enter the user parameters.

#### General parameters

- View version number:

Including Display hardware version, display software version and Motherboard Checksum.

- Wi-Fi connection :

Click on the Wi-Fi button, select the internet mode as AP or EZ. And then there will be a QR code for WiFi connection.

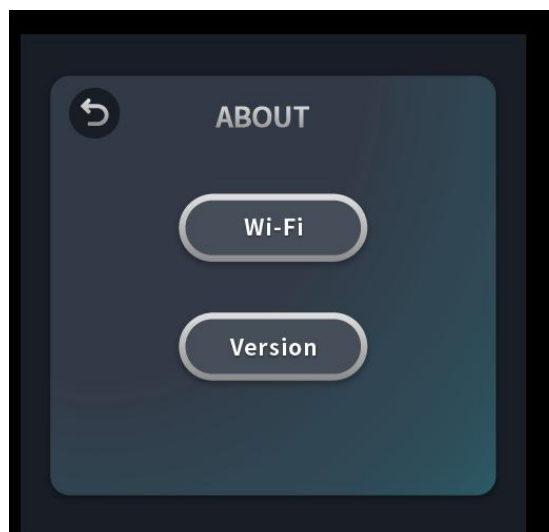

## Time settings

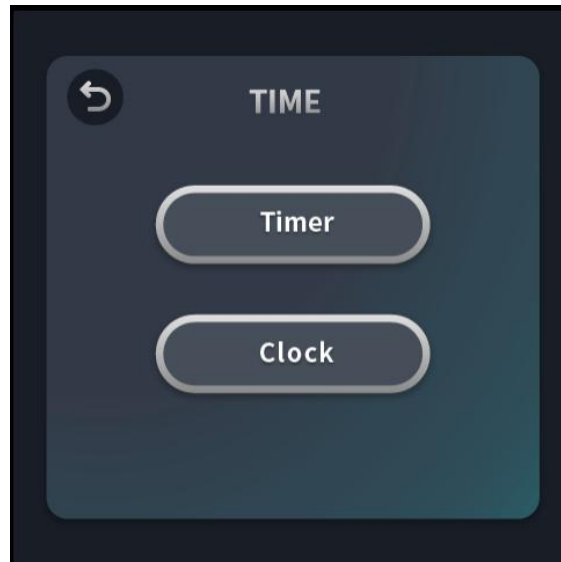

- **Timer**

Click on “” to enter the Timer ON/OFF setting interface.

- a. Timer on/off setting time range:8\*24;
- b. The timer function is not enabled if the timing on is the same as timing off;
- c. The timer function is not enabled when the timer switch is not turned on;
- d. The NO group means timed on, The OFF group means timed off;

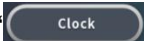
- **Clock:** click on “” to enter the Time setting interface.

Setting rules: Day-Month-Year-Hour:Minute

### 4.2.9 Curve

- a. Slide to the rightmost interface to enter the curve display ;
- b. Refresh curve every hour, display up to 7 data;
- c. If the power failure more than 7 days, the curve will be cleared; if the power failure does not more than 7 days, the data will be displayed as 0 for the duration of the power failure;
- d. The latest data of the curve is on the far right.

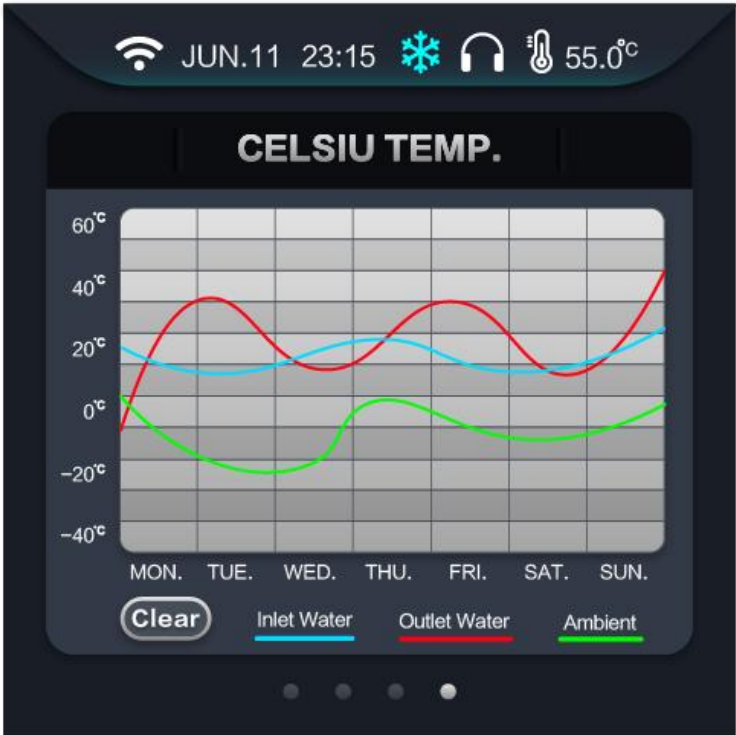

### 4.3. User Parameters

Code	Meaning	Range	Modbus Address	Default
A1	Heating target temp.	20°C~A7	105	27
A2	Cooling target temp.	A8~30°C	106	27
A3	Automatic target temp.	A8~A7	108	27
A10	Temp. compensation value	-10~10°C	127	0
B02	Remote monitoring address	0~255	128	0
P01	Pump control mode	0~5 (0.Keep running at constant Temp. 1. Keep running at constant Temp. for two min. and then off. 2. Run water pump at intervals at constant Temp. 3. Shared unit water pump, keep running at constant Temp. 4. Shared unit water pump, keep running at constant Temp. for two min. and then off. 5. Shared unit pump, run water pump at intervals at constant Temp.)	124	2
P02	Water pump interval running time	0~120min	125	55min

## 4.4. Fault & Protections

When the unit is fault, some faults will cause the display to have an alarm output, and the icon "!" will flash, click the fault icon button to view the current fault.

When another part of the fault occurs, the display will not alarm and the icon "!" will not flash. " -.- " is displayed when the temperature sensor is fault.

Code	Meaning	Code	Meaning
E01	Wire Controller communication protection	E35	Phase B wrong phase fault
E02	Flow switch fault	E36	Phase C wrong phase fault
E03	High pressure protection	E37	AC current protection
E04	Low pressure protection	E38	AC voltage protection
E06	Driver board communication protection	E39	DC voltage protection
E07	Abnormal Communication between driver and main board	E40	Phase current protection
E10	Inlet water temp. sensor fault	E41	DC current protection
E11	Outlet temp. sensor fault	E42	High pressure sensor fault
E13	Ambient temp. sensor fault	E43	Low pressure sensor fault
E15	Suction temp. sensor fault	F01	AC input current over-current shutdown
E16	Exhaust temp. sensor fault	F02	AC input voltage under-voltage
E17	Outer coil temp. sensor fault(Heating)	F03	Transformer output 15V under-voltage protection
E18	Inner coil temp. sensor fault(Cooling)	F13	IPM temp. overheat protection
E22	High coil temp. protection(Cooling)	F15	Compressor over-current
E23	Low inner coil temp. protection (Cooling)	F20	PFC fault
E24	High outlet water temp. protection (Heating)	F21	IPM fault
E25	Low outlet water temp. Protection (Cooling)	F25	DC bus over-voltage protection
E26	Inlet and outlet water temp. difference protection	F26	DC bus under-voltage protection
E27	High exhaust temp. protection	F38	DC fan 1 fault
E30	Low ambient temp. protection (Heating)	F43	DC fan fault
E30	Low ambient temp. protection (Cooling)	F44	Driver compressor Driver fault
E31	High pressure switch fault	F45	IPM protection (permanent)
E32	Low pressure switch fault	F46	Driver protection(permanent)
E33	Out of phase fault	F47	IPM temp. protection
E34	Phase A wrong phase fault	F48	IPM overheat protection

## 5. Wi-Fi Settings

### 5.1 Software Installation

- ① Method 1: Search “Smart life” in your APP store, install “”. Click “GET” to install.

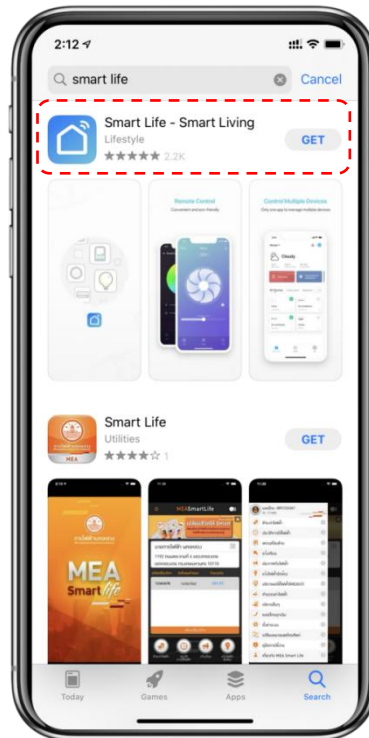

- ② Method 2: Scan the QR code below.



For IOS and Android Users





## 5.2 Software Startup

After install, click “” on your desktop to start up Smart Life.





## 5.3 Software Registration and Configuration

### 1. Registration

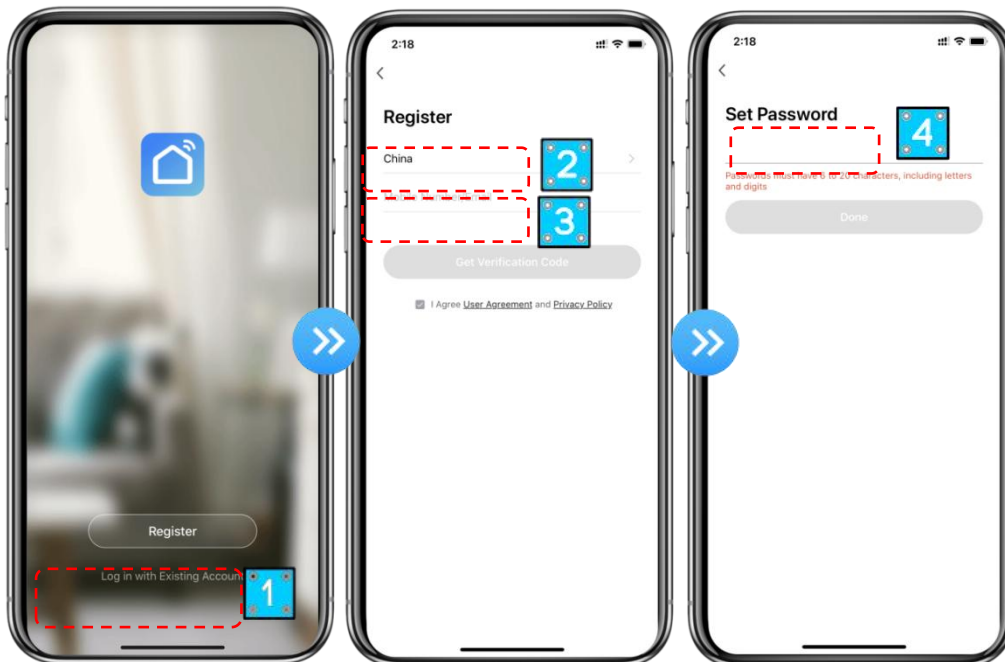
- ① Users don't have account can click “Register” to create an account: Register  Enter your phone number  Get Verification Code  Enter Verification Code  Set Code;



- ② After registration, you need to create a Home: Create a Home  Set Home Name   
Set Home Location  Add Rooms.

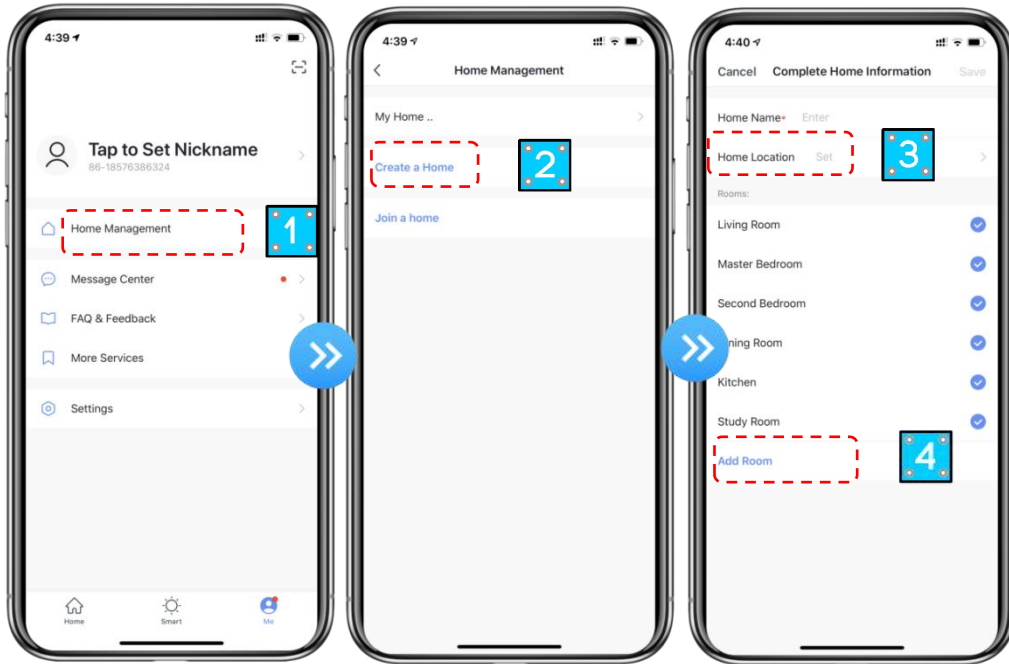

## 2. Account ID+ Password Login

- ① Existing accounts can be logged in directly, in the following order.

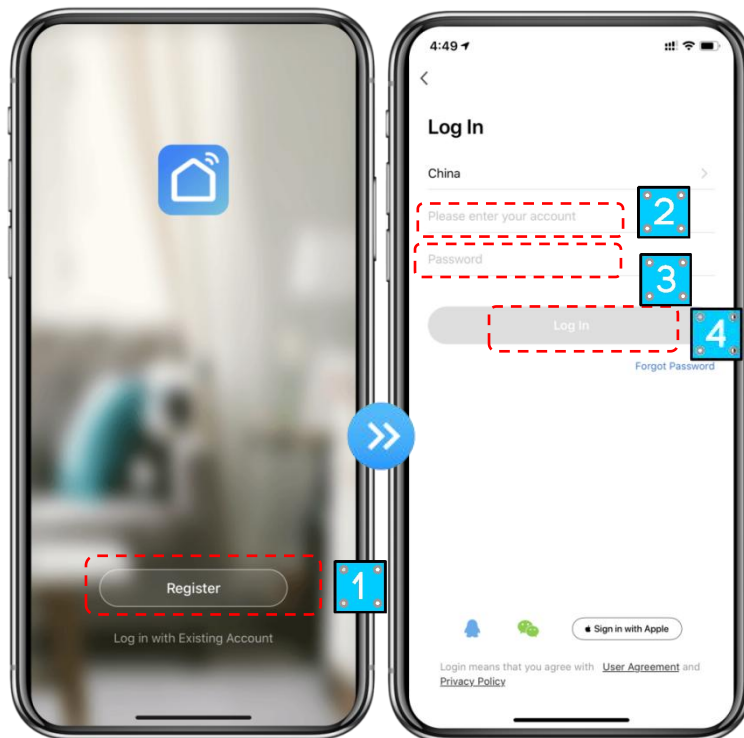

- ② If you forget your password you can choose to login with your verification code and select "Forget Password": Enter your phone number → Get verification code.



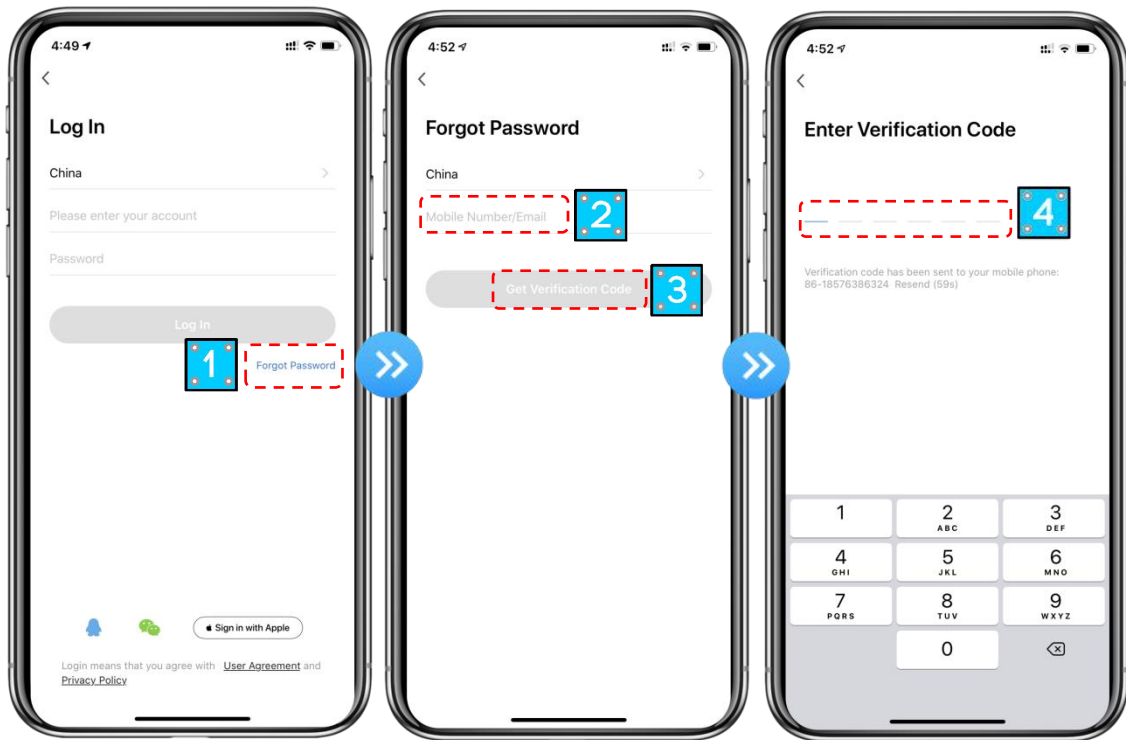

③ After creating a home or logged in, enter the main interface of APP.



**Note:**

Click the device to check the status, and you can set the operating mode, ON/OFF, timer. Click “+” to add devices.

## 5.4 Wi-Fi Connection

### Method 1(Scan the QR code to connect)

#### Step 1:

“Setting interface” → “About” → “Wi-Fi”

Then select the internet mode as AP or EZ. And then a QR code will appear on the screen of the controller.



#### Step 2:

Turn on the phone's Wi-Fi function and connect to the Wi-Fi hot-spot. The Wi-Fi hot-spot must be able to connect to the Internet normally;

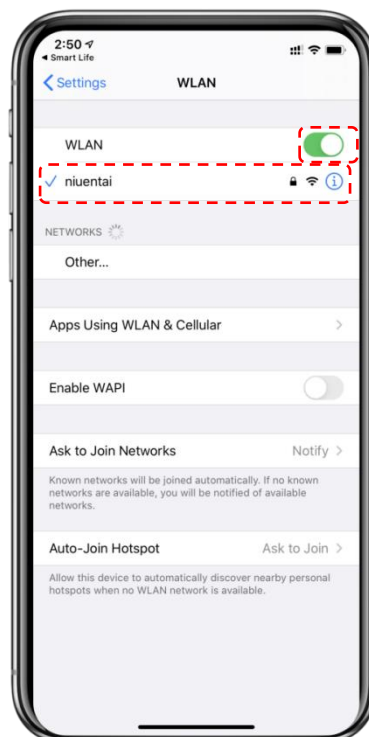

**Step 3:**

Open the "Smart Life" APP, log into the main interface, click on the top right corner "+" of the interface, enter the equipment type selection interface; Then click on the top right corner " " of the interface, scan the QR code on the screen for device connection.

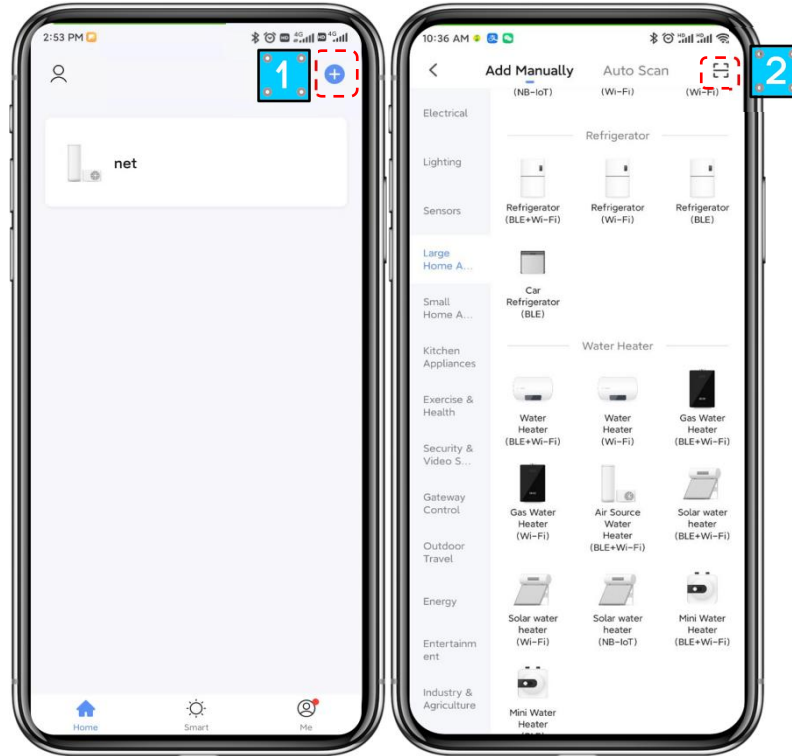

**Step 4:** Click "Add", and then directly enter the connected status of the device, the user interface is as follows:

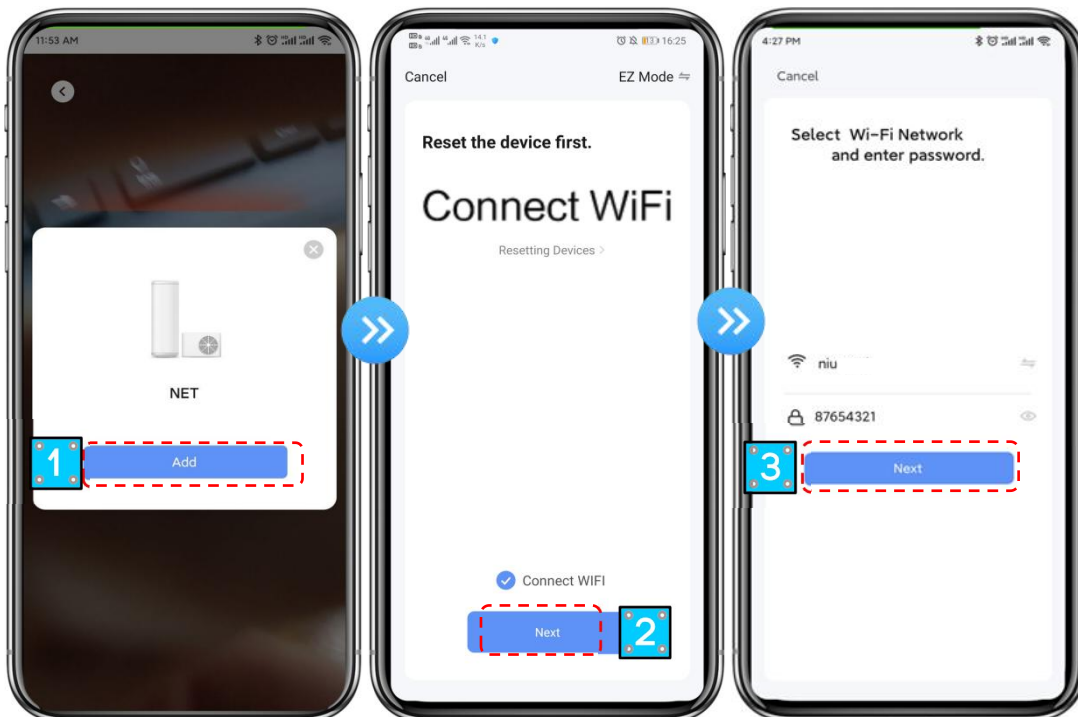

### Step 5:

When “Scan devices”, “Register on cloud”, “Initialize the device” are all completed, connect succeeds.

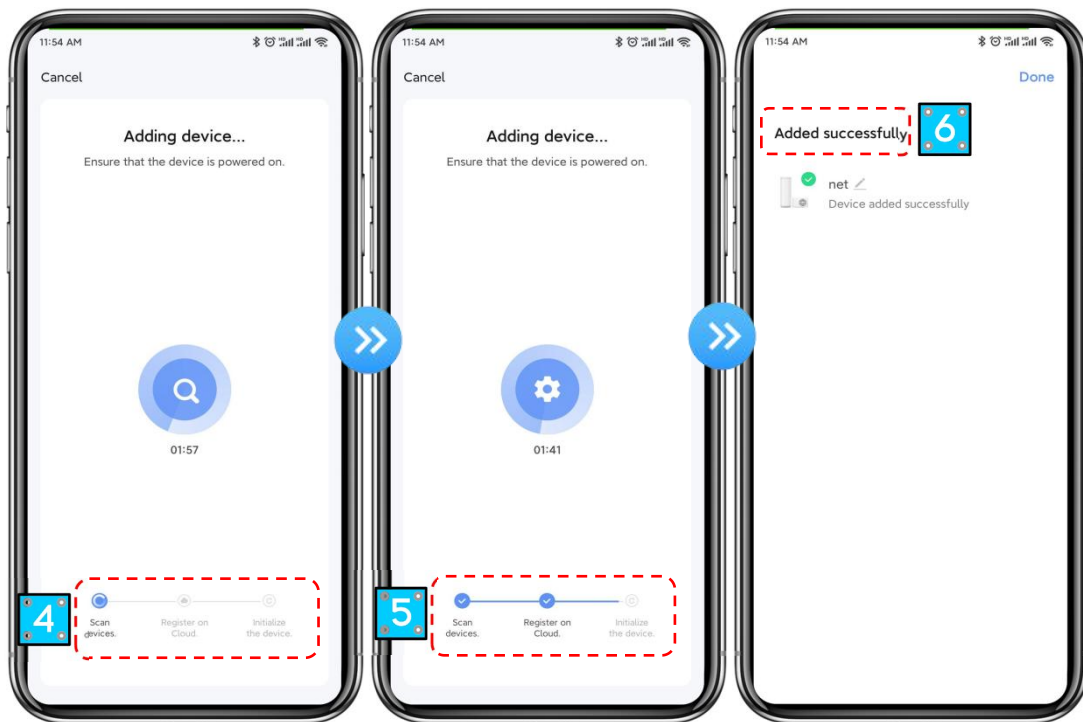

### Method 2(Add Manually)

**Step 1 & Step 2** are the same as Method 1 above.

### Step 3:

Open the "smart life" APP, log in into the main interface, click on the top right corner "+" or "add equipment" of the interface, enter the equipment type selection, the "Large Home Appliances" , select "Smart Heat Pump" equipment and add equipment into the interface.

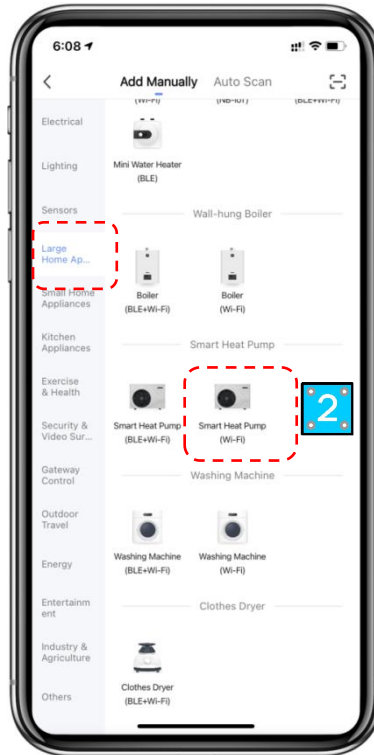

**Step 4:**

After entering the add device interface, click "Confirm the indicator is blinking rapidly" and "Next". The interface of Wi-Fi connection will pop up, enter the Wi-Fi password of the mobile phone (it must be the same as the Wi-Fi of the mobile phone), and click "Next". Enter the mobile phone Wi-Fi connection interface, and the APP will automatically enter the device connection status.

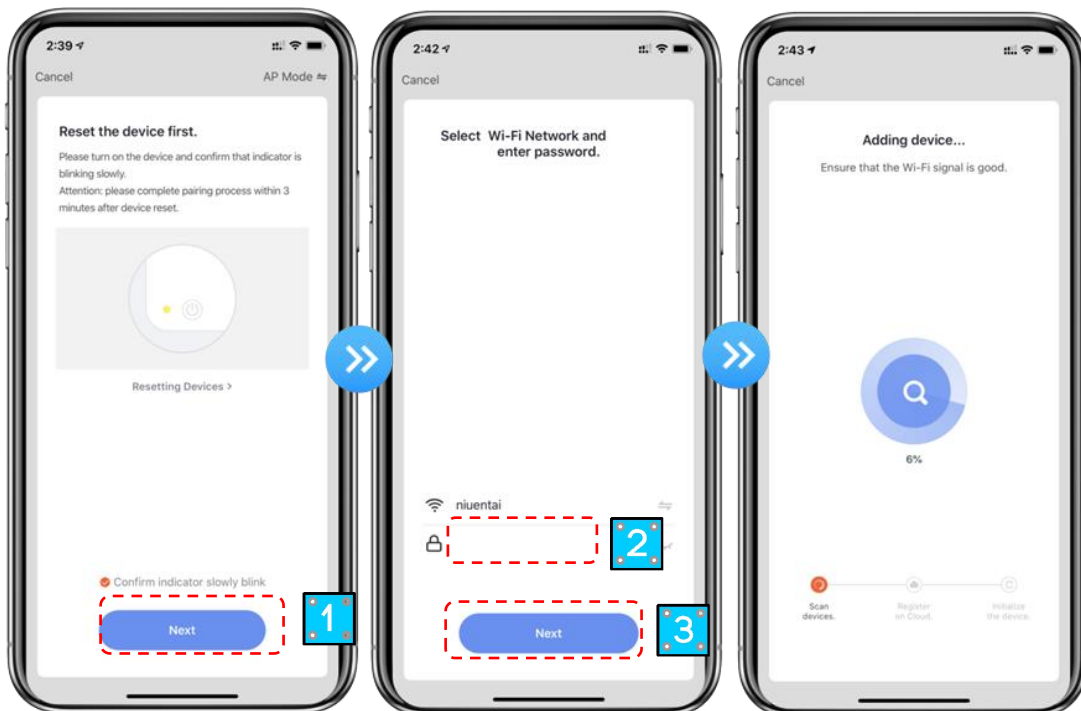

**Step 5:**

When “Scan devices”, “Register on Cloud”, “Initialize the device” are all completed, connect succeeds.

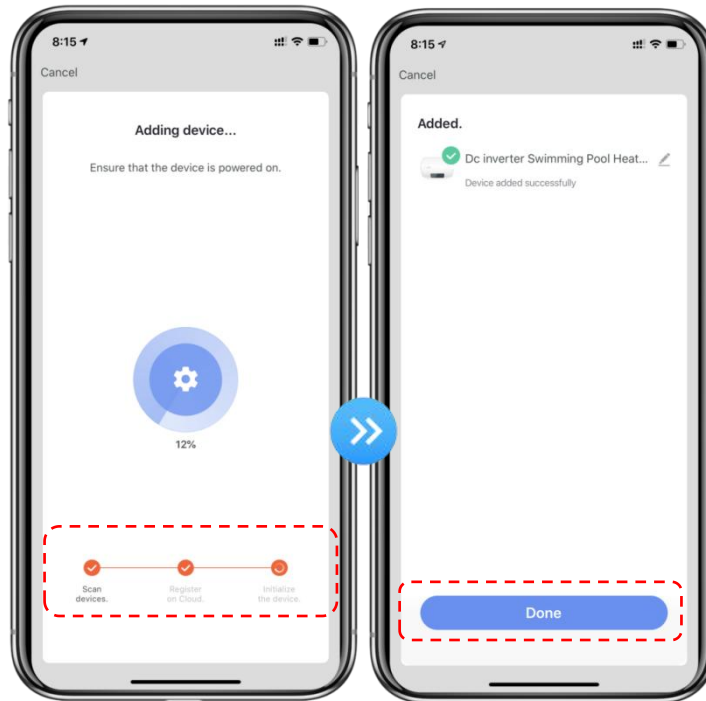

### Method 3(Bluetooth connect)

#### Step 1:

Turn on the phone's Bluetooth and Wi-Fi function, then connect to the Wi-Fi hotspot. The Wi-Fi hotspot must be able to connect to the Internet normally.

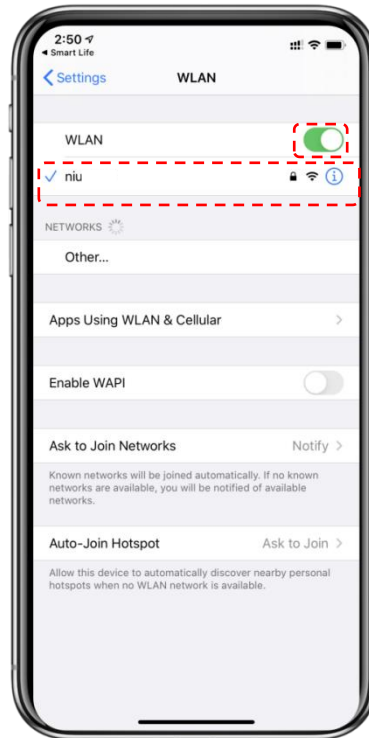

#### Step 2:

If you have already turned on the phone's Bluetooth and Wi-Fi function, it will automatically pop up the searched machine. Click "Go to add" to connect the machine. The next steps are the same as method 2.

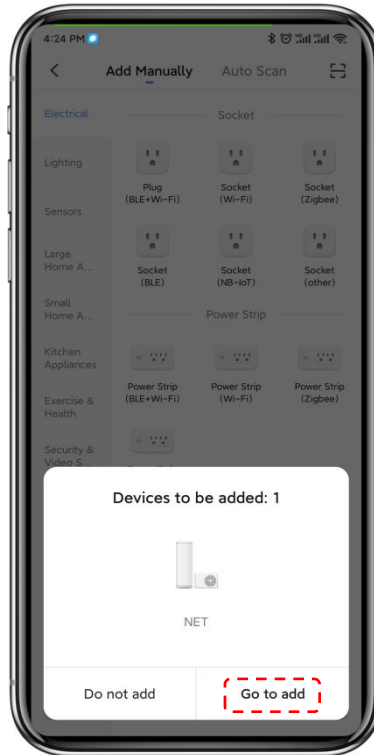

**Step 3:**

Choose Wi-Fi and enter the password.

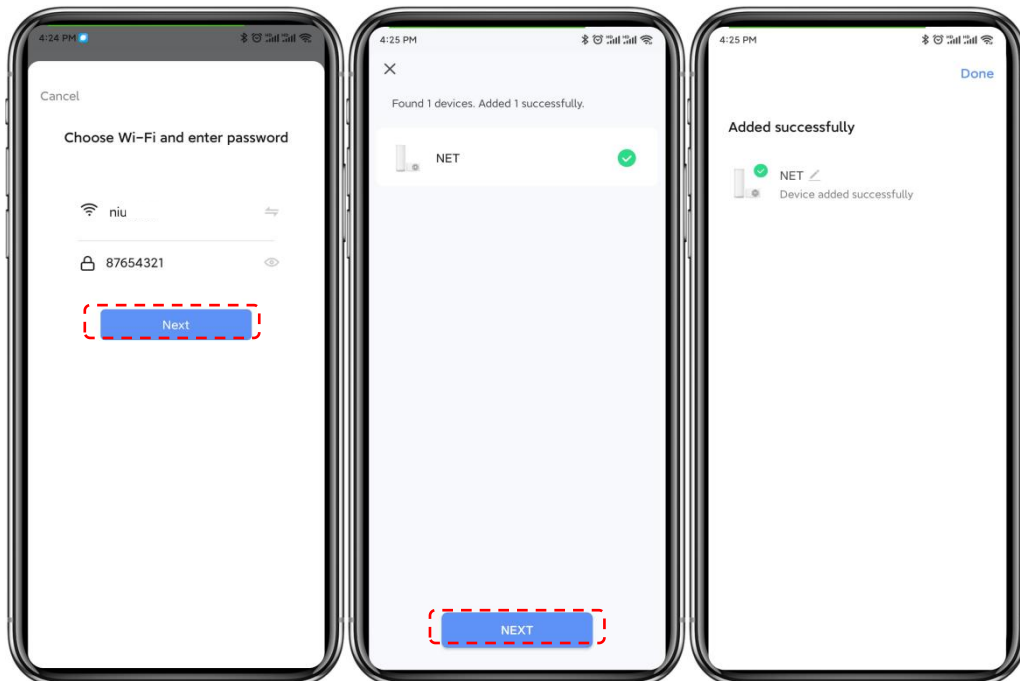

**Note:** If the connection is failed, please enter the AP mode manually and reconnect according to the above steps.



## 5.5 Software Function Operation

- After the device is bound successfully, enter the operation interface of “Smart heat pump” (Device name, modifiable)
- In the main interface of “Smart Life”, click “Smart heat pump” to enter the operation interface.



- ① Back
- ② More: You can change device name, select device installation location, check networking status, add Shared users, create device cluster, view device information, and more.
- ③ Setting temp. adjustment: The circle slides counterclockwise to reduce the temp., but clockwise to increase the temp..
- ④ Target temp.
- ⑤ Current temp.
- ⑥ ON/OFF
- ⑦ Mode switching: Click to select the mode to be switched.
- ⑧ Timing: Click to add timing off/on time.

- **Modify device name**

Click in the following order to enter device details, and click "Device Name" to rename the device.

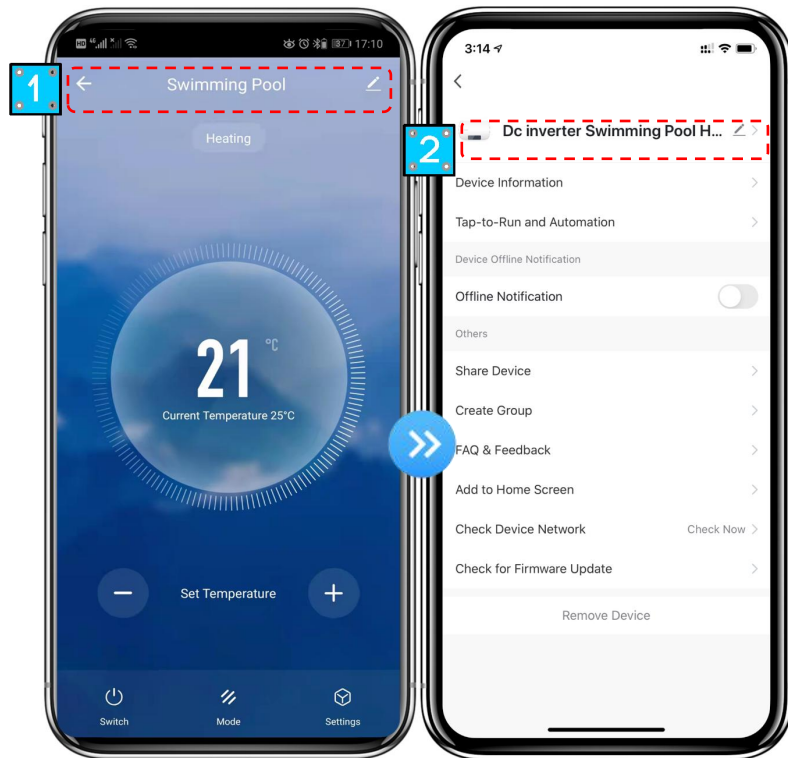

● **Device sharing**

- ◆ To share a bound device, the user should do so in the following order.
- ◆ After successful sharing, the list will be added to show the person shared
- ◆ If you want to delete the account you shared to, cross the selected account to the left, and delete it.
- ◆ The user interface is as follows.

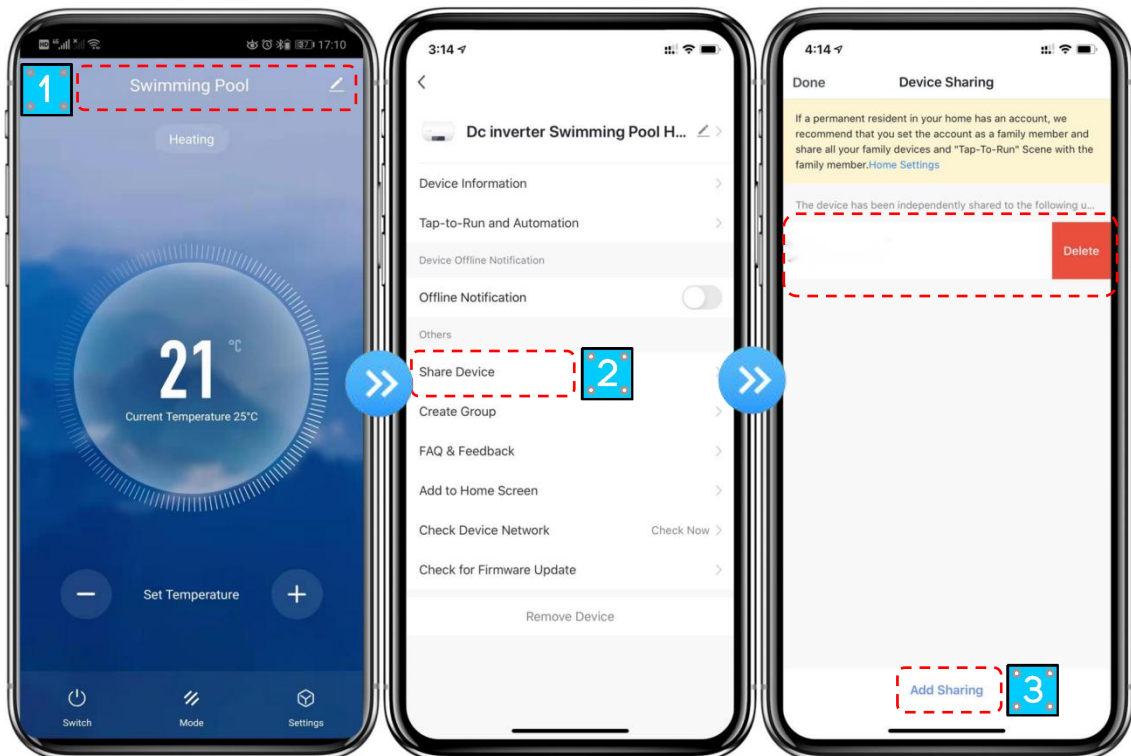

- ◆ Enter the account of the shared, click "Done", and the share success list shows the newly added account of the Shared.

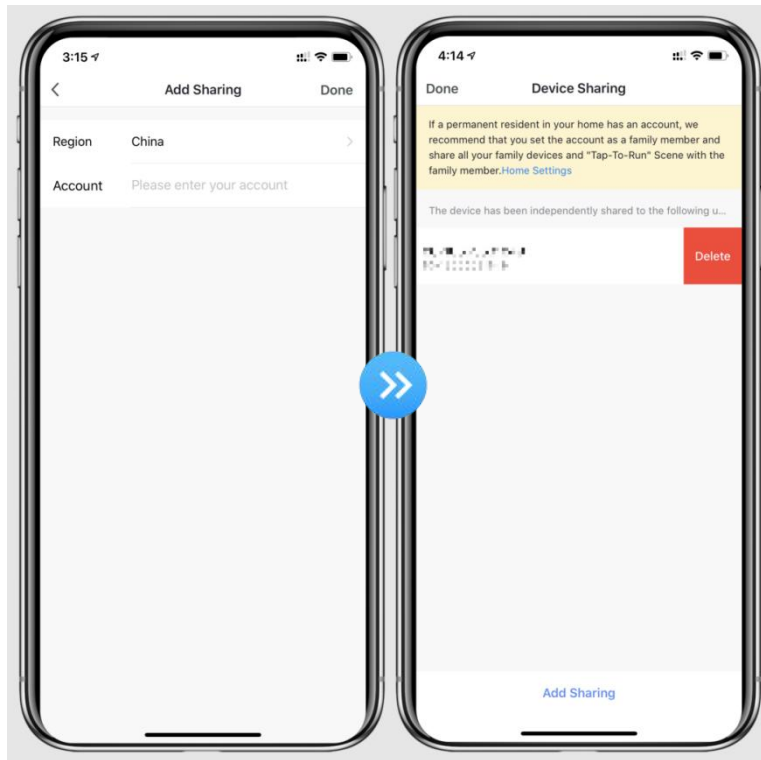

- ◆ The interface of the person to be shared is as follows. The received shared device is displayed. Click it to operate and control the device.



● **Mode settings**

Click “” on the main interface to switch modes, select what you need.

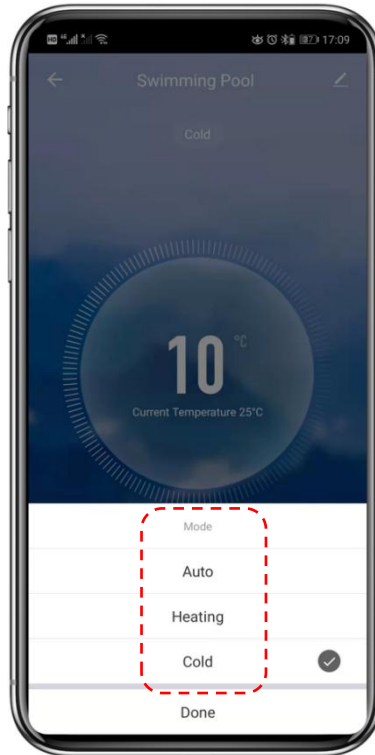

● **Timer setting**

1. Click “” on the main interface to enter timer setting interface, as shown below, click to add timer.



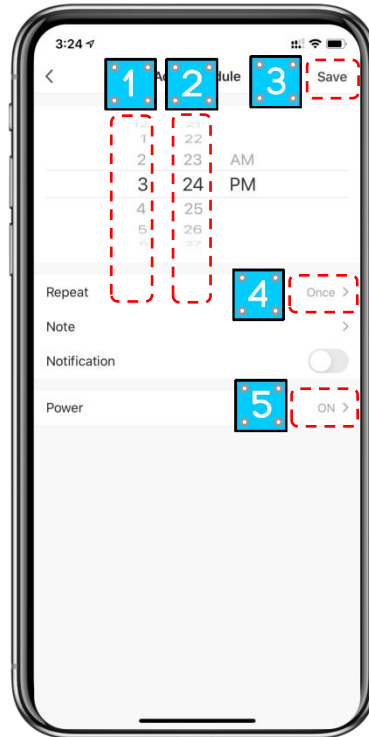

1. After entering timer setting, swipe up/down to set timer, set up repeat weeks and on/off, then click “save” to save your settings as follows.



- ① Hours
- ② Minutes
- ③ Set the repetition
- ④ Set power ON/OFF
- ⑤ Save your modification

## 5.6 Device Removal

Click “” on the top right corner of the main interface to enter the device details interface, and click “device removal” to enter EZ mode. Indicator light under “” flashes rapidly for 3min, the network can be reconfigured within 3 minutes, and the network can be quit if it is not connected within 3 minutes. The specific operations are shown as follows.

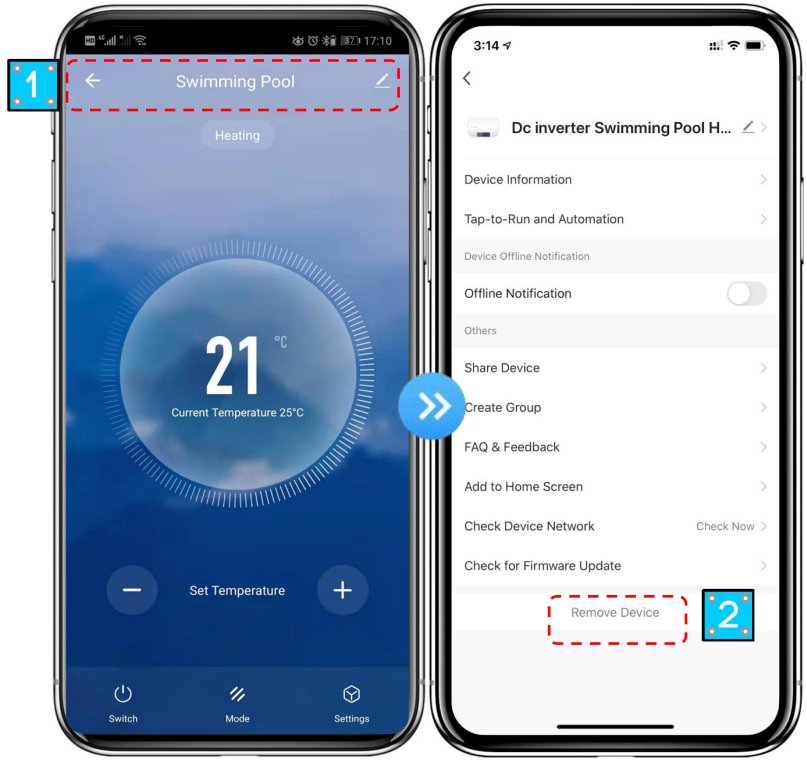



## 6. MAINTENANCE AND WINTERIZING

### 6.1 Maintenance

 **WARNING:** Before undertaking maintenance work on the unit, ensure that you have turned off the unit at the electrical power supply at the isolator and also at the main power board.

#### 1. Cleaning

- a. The heat pump's casing must be cleaned with a damp cloth. The use of detergents or other household products could damage the surface of the casing and affect its properties.
- b. The evaporator at the rear of the heat pump must be carefully cleaned with a vacuum cleaner and soft brush attachment.

#### 2. Annual maintenance

The following operations must be undertaken by a qualified person at least once a year.

- a. Carry out safety checks.
- b. Check the integrity of the electrical wiring.
- c. Check the earthing connections.
- d. Monitor the state of the pressure gauge and the presence of refrigerant.

### 6.2 Winterizing



**“CUT OFF” power supply of the heater before cleaning, examination and repairing**

In winter season when you don't swim:

- a. Cut off power supply to prevent any machine damage.
- b. Drain water clear of the machine if in danger of snow or freezing.

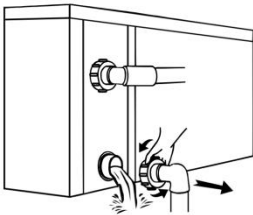

**!! Important:**

Unscrew the water nozzle of inlet pipe to let the water flow out. When the water in machine freezes in winter season, the titanium heat exchanger may be damaged.

- c. Cover the machine body when not in use.



## 7. Warranty Information

TDI Unit Warranty  
30 Years Titanium Heat Exchanger (Pro Rata)  
6 Years Compressor  
2 Years Electronics  
1 Year Labour

Warranty Conditions Apply - to download the latest warranty please visit  
[www.australianenergysystems.com.au](http://www.australianenergysystems.com.au)

### **Contact Information** - Australian & NZ Distributor

Australian Energy Systems  
Unit 17/6 Maunder St  
Slacks Creek Qld  
Australia 4127

Phone: 0732992700

Web: [www.australianenergysystems.com.au](http://www.australianenergysystems.com.au)





Manual P/N: T119-01-10-00662 A